

FoMaKo

NDI/HDMI/USB IP PTZ CAMERA

User Manual (V1.1)



FoMaKo

E-mail: ivan@fomako.net

Website: www.fomako.net

Phone: 0086-18565635753

Address: 10F NiuLanQian Building, Minzhi,
longhua, shenzhen, China, 518000

Please feel free to contact us if you have any questions.

Please Note: Only NDI version cameras have NDI function, other version cameras don't have NDI function.

FoMaKo IP Streaming Camera Quick Start

Dear Friend,

Thanks for ordering FoMaKo cameras. To setup your streaming system easier, please read this quick start instruction first.

Video Out Methods:

- (1) HDMI video output:
 - HDMI port to HDMI TV/monitor, to preview video and change camera setting by press “menu” on remote control
 - HDMI port to HDMI video switch/mixer
 - Use HDMI to USB video capture card converting HDMI signal to USB signal, then, you can use this camera as normal USB camera
- (2) LAN Video output: Before using “LAN Video Out”, we should add the camera to your network.
- (3) USB Video out, you can use the camera as an USB webcam

(This camera comes with newest firmware with DHCP enable, network settings is much easier than other cameras.)

How to find out camera's IP:

Please keep your camera connect to the router, only router can assign IP address for the camera.

If router can't assign IP address for camera successfully, camera will keep default IP address: 192.168.5.163

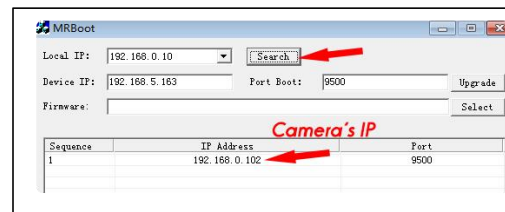

Method One:(By tool)

Step 1: Download FoMaKo Camera IP Scanner tool and run it:

Go to our official support site: www.fomako.net, search “T01”, download and run it.

Step 2: Click “search”, you can see camera's IP

(Please note: This tool can only run from Windows OS, and computer must be connected to the same router which camera connected to.)

Method Two:(By HDMI)

Step 1: Camera HDMI port ->HDMI Cable->TV/monitor-> Camera's video come out on your screen

Step 2: Go to camera's menu by press “menu” button on remote control -> Network-> IP Addr.

you can see camera's IP address which assigned by your router. Please check the picture, this camera's IP is 192.168.0.100, you can also change camera's IP address from here.

Method Three:(By USB)

Step1: Camera USB port-> USB cable-> Computer USB port

Step2: Run computer's Camera App (any camera software is ok), it will recognize FoMaKo camera,

Step3: Go to camera's menu by press “menu” button on remote control -> Network-> IP Addr.

you can see camera's IP address which assigned by your router.

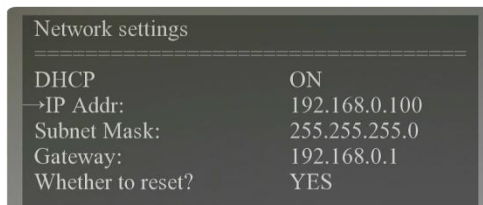

Turn off “DHCP”

You can turn off DHCP from camera' menu or from camera's webpage

(Important: turn off DHCP, the camera will keep currently IP address, otherwise when camera reboot, the IP address will be changed.) If you want to move camera to another network, you'd better turn on DHCP first, then router will assign new IP address for camera.

Login Camera's Webpage

Now, you can login camera's webpage by camera's IP address: 192.168.0.100.
we recommend to use Google Chrome.

username: admin password: admin

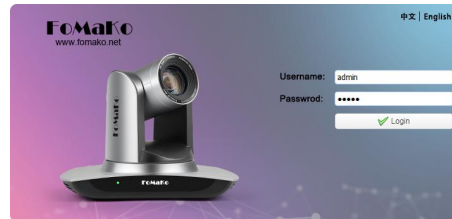

Add Camera to IP PTZ Controller:

Some information you need:

IP Visca port: 1259 Sony Visca port: 52381 Onvif Port: 2000 User Name: admin Password: admin

We recommend to use Sony Visca or IP Visca control protocol, the two protocols are more steady and work better.

Let's use FoMaKo KC608 Pro IP controller for example:

FoMaKo KC608 Pro controllers are optimized for FoMaKo cameras, it is very easy to let them work together.

- (1) Add the controller to the same LAN as camera, the router will assign an IP address for IP controller
- (2) Press "search" button on controller, it will show camera's IP address
- (3) Choose "VISCA Over IP" and press "Enter"
- (4) Add to Shortcut Keys, you can assign 7 cameras to shortcut keys CAM1~CAM7
- (5) Press CAM1~CAM7 to control the camera

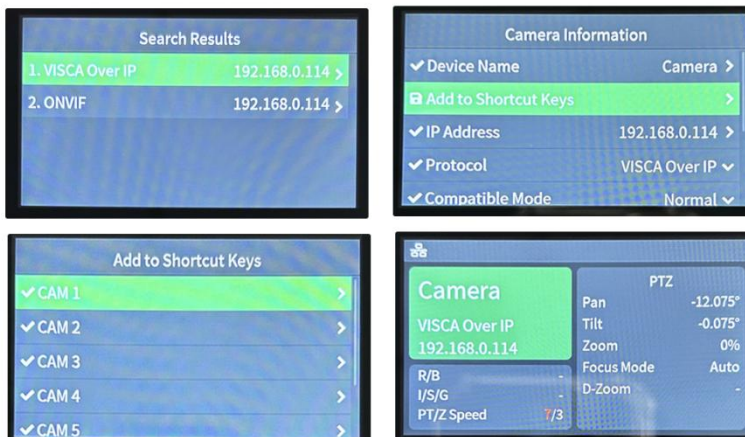

How To Enable AI Tracking

F1: Turn off auto tracking

F2: Turn on auto tracking

F3: Switch auto tracking modes

F4: Switch auto tracking to follow a different person

(Note: The AI tracking is signal person tracking, you'd better don't block the track target)



If you need more supports, please contact us at: ivan@fomako.net, normally, we can reply you within 12hours.

FoMaKo Supports Team

⚠️ Attention

Improper operations may damage the product structure and result in mechanical failure. Please note the following tips:

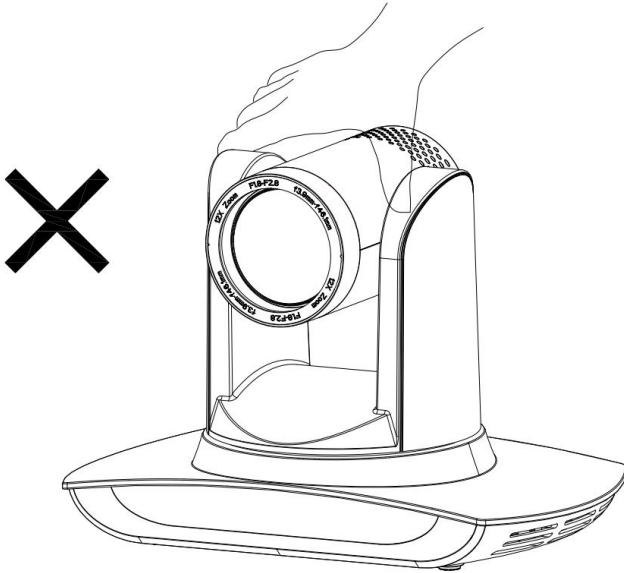

⚠️ Do not move the camera by grabbing the head.



Move the camera by holding the bottom with one or both hands.

⚠️ Please do not rotate the lens and holder manually no matter the camera is power on or off; otherwise it may damage the camera structure and result in failure of camera self-check and unable to start the camera.

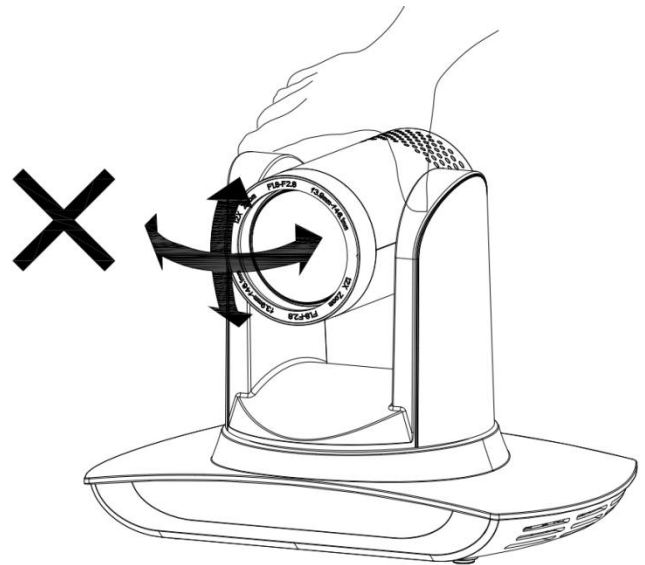

This manual introduces functions, installations and operations for this PTZ camera in details. Please read this manual carefully before installation and use.

1. Cautions

- 1.1 Avoid damage to product caused by heavy pressure, strong vibration or immersion during transportation, storage and installation.
- 1.2 Housing of this product is made of organic materials. Do not expose it to any liquid, gas or solids which may corrode the shell.
- 1.3 Do not expose the product to rain or moisture.
- 1.4 To prevent the risk of electric shock, do not open the case. Installation and maintenance should only be carried out by qualified technicians.
- 1.5 Do not use the product beyond the specified temperature, humidity or power supply specifications.
- 1.6 Wipe it with a soft, dry cloth when cleaning the camera lens. Wipe it gently with a mild detergent if needed. Do not use strong or corrosive detergents to avoid scratching the lens and affecting the image;
- 1.7 This product contains no parts which can be maintained by users themselves. Any damage caused by dismantling the product by user without permission is not covered by warranty.

2. Electrical Safety

Installation and use of this product must strictly comply with local electrical safety standards. The power supply of the product is $\pm 12V$, the max electrical current is 2A .

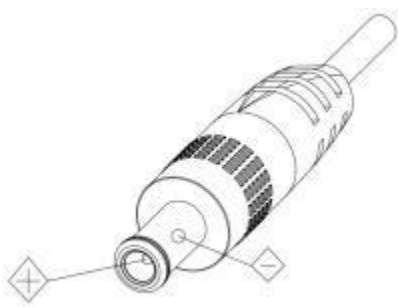

3. Install

- 3.1 Do not rotate the camera head violently, otherwise it may cause mechanical failure;
- 3.2 This product should be placed on a stable desktop or other horizontal surface. Do not install the product obliquely, otherwise it may display inclined image;
- 3.3 Ensure there are no obstacles within rotation range of the holder.
- 3.4 Do not power on before completely installation.

4. Magnetic Interference

Electromagnetic fields at specific frequencies may affect the video image. This product is Class A. It may cause radio interference in household application. Appropriate measure is required.

Content

1. Camera Installation	2
1.1 Camera Introduction	2
1.2 Interfaces and Connection	3
2. Product Overview	4
2.1 Dimension	4
2.2 Accessory	4
2.3 Main Features	5
2.4 Technical Parameter	5
3. Remote Control	8
3.1 Keys Introduction for IR Remote Control	8
3.2 Menu Introduction	1 1
4. Network Configuration	1 3
4.1 Network Connection	1 3
4.2 Web Login	1 3
4.3 Streaming	1 4
4.4 Software Upgrading	1 6
5. Serial Port Communication and Control	1 9
5.1 VISCA Protocol Return Command	1 9
5.2 VISCA Protocol Control Command	1 9
5.3 VISCA Protocol Inquiry Command	2 2
5.4 Pelco-D Protocol Command List	2 4
5.5 Pelco-P Protocol Command List	2 4
6. Maintenance and Troubleshooting	2 6
6.1 Camera Maintenance	2 6
6.2 Troubleshooting	2 6
7. Example: Streaming to Facebook	2 7
8. Example: Streaming to Youtube	2 8
9. Example: Streaming to Vmix	2 9
10. Copyright Statement	2 9

1. Camera Installation

1.1 Camera Introduction

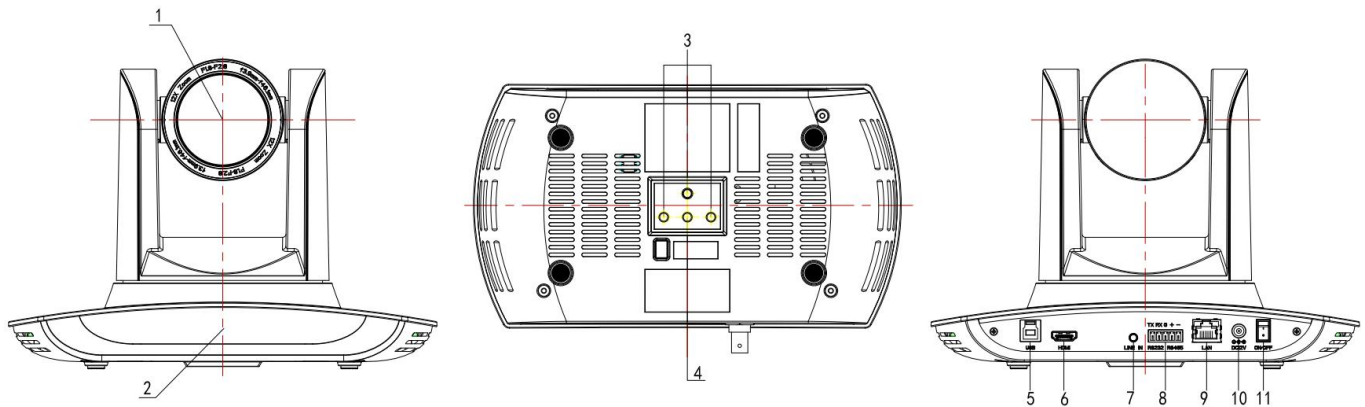

Figure 1.1 Interface of ST (standard) Model

- | | |
|--------------------------------------|-------------------------------------|
| 1. Camera Lens | 6. HDMI |
| 2. Receiving Light | 7. Audio In Jacket |
| 3. Hole for Installation
Fixation | 8. RS232/RS485 Input |
| 4. Screw Hole for Tripod | 9. LAN (POE&NDI optional) Port |
| 5. USB 3.0 | 10. DC12V Input Power Supply Socket |
| | 11. Power Switch |

1.2 Interfaces and Connection

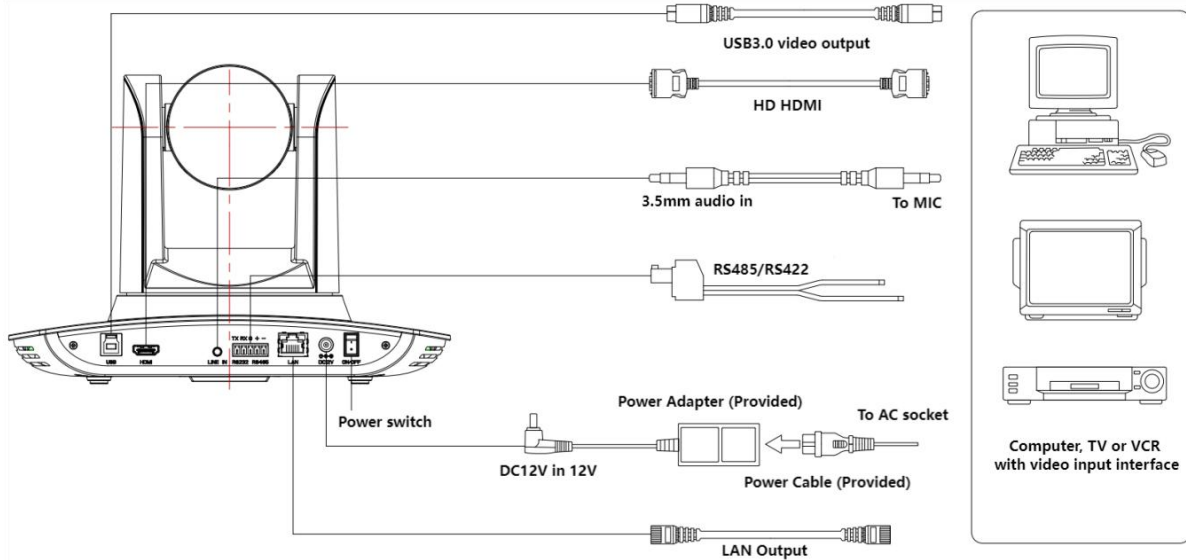

Figure 1.2 Wiring Diagram

- 1) After power on and self-checking, the camera will automatically return to the preset 0 position if it's pre-set.
 - 2) The default address for the IR remote control is 1#.
- If restore the menu to factory defaults, the remote control address will restore to 1#.

2. Product Overview

2.1 Dimension

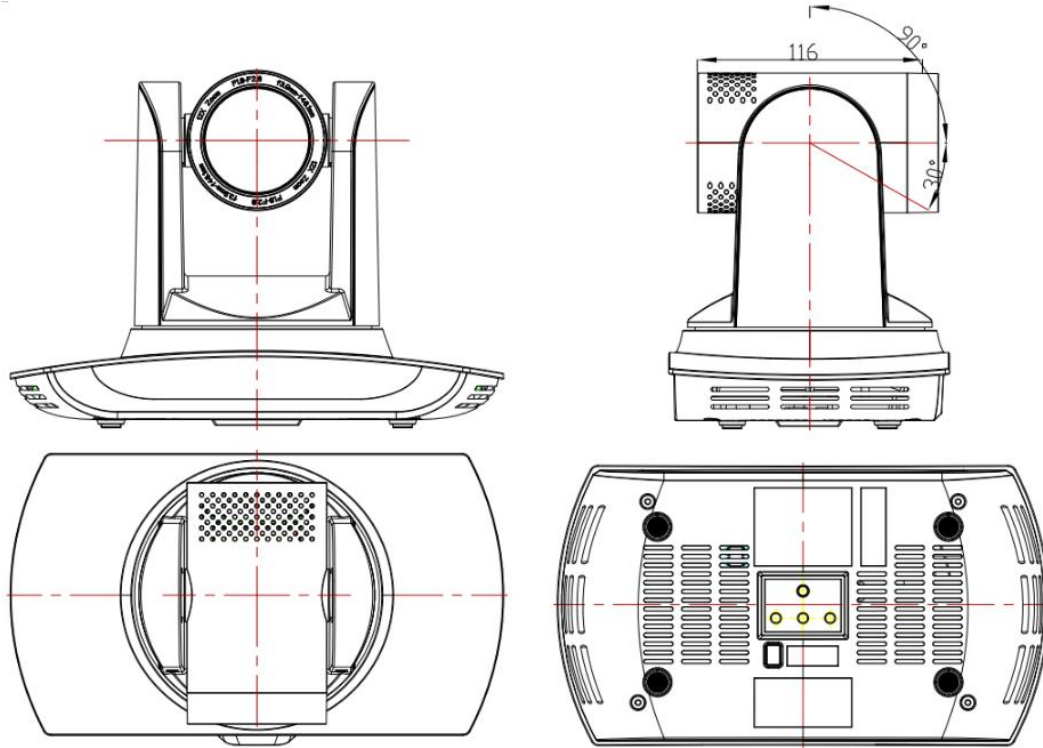

Figure 2.2 Product Dimension

2.2 Accessory

Please check below standard and optional accessories when unpacking the box.

Standard Accessory	Optional Accessory
Power Adapter	Wall Mount
IR Remote Control	Ceiling Mount
USB3.0 Cable	
Operating Manual	
RS232 Control Cable	

2.3 Main Features

This series camera has perfect functions, superior performance and rich video output interfaces; Featuring with advanced ISP processing algorithms, offering vivid and high resolution video with a strong sense of depth and fantastic color rendition. It supports H.264/H.265 encoding which makes motion video more fluent and clear under low bandwidth conditions.

- **UHD HD Resolution:** Resolution is up to 3840x2160 with frame rate up to 30fps .
- **Optical Zoom Lens:** 20X.
- **Leading Auto Focus Technology:** Fast, accurate and stable auto focusing technology.
- **Low Noise and High SNR:** Super high SNR image is achieved with low noise CMOS. Advanced 2D/3D noise reduction technology further reduces the noise while ensuring high image clarity.
- **Multiple Video Output Interfaces:** HDMI, LAN, USB3.0; LAN (POE&NDI function is optional, please consult the dealer for specific models).
- **Multiple Audio/Video Compression Standards:** Support H.264/H.265 video compression, up to 3840x2160 resolution 30fps; support AAC audio compression. 48000 sampling frequency.
- **Built-in Gravity Sensor:** Support PTZ auto-flip function and easy installation.
- **Multiple Network Protocol:** Support ONVIF, GB28181, RTSP, RTMP, VISCA OVER IP, IP VISCA, RTMPS, SRT, NDI protocols; Support RTMP push mode, easy to be connected to streaming server (Wowza, FMS); Support RTP multicast mode; Support network full command VISCA control protocol.
- **Control Interface:** RS232/RS485 control camera.
- **Multiple Control Protocol:** Support VISCA, PELCO-D, PELCO-P protocols; Support automatic identification protocols.
- **Quiet Pan / Tilt Movement:** With high accuracy step driving motor, camera can pan / tilt extremely quiet and smooth.
- **Sleep function with low power:** Support sleep/wake up function with low power consumption, less than 400mw.
- **Multiple Presets:** Up to 255 presets (10 presets via remote control).
- **IR Remote Control:** Users can use IR remote control to control the camera, can also do menu settings by HDMI and USB Connection to display device.(LAN connection can't use menu setting by IR Remote Control)
- **Multiple Application:** Online-education, Lecture Capture, Webcasting, Video conferencing, Tele-medicine, Unified Communication, Emergency command and control systems, etc.
- **AI humanoid tracking:** built-in high-speed processor and the use of exclusive advanced image processing and analysis algorithms, users can choose real-time tracking and regional tracking according to the use of the environment, you can click the person object box through the web page to switch tracking objects.

2.4 Technical Parameter

Model	20X
Camera Parameter	
Optical Zoom	f=5.1-94.5mm
Sensor	1/2.8 inch high quality Sony CMOS sensor
Effective Pixels	8.42MP, 16: 9
Video Format	HDMI: 4KP30、4KP25、1080P60、1080P50、1080P30、1080P25、720P60、720P50、1080P59.94、1080P29.97、720P59.94

	USB3.0: YUY2/NV12: 1920×1080/1280×720/1024×576/800×600/800×448/640×360/640×480/480×270/320×180@30fps; MJPG/H264: 3840×2160/2560×1440/1920×1080/1600×896/1280×720/1024×576/960×540/800×600/800×448/720×576/720×480/640×480/640×360/480×270/352×288/320×240@30fps; LAN: Main stream: H264/H265: 3840×2160/1920×1080/1280×720/640×360/640×480@30/25/20/15/10/5fps; Sub-streams: H264/H265: 1920×1080/1280×720/640×360/640×480/320×240/320×180@30/25/20/15/10/5fps;
View Angle	3.5° (N) 60° (W)
AV	F1.8 – F2.9
Digital Zoom	15X
Minimum Illumination	0.5 Lux (F1.8, AGC ON)
DNR	2D & 3D DNR
White Balance	Auto/Manual/One-push/2400K/3000K/3500K/4000K/4500K/5000K/5500K/6000K/6500K/7000K/7100K
Focus Mode	Auto/Manual/One Push Focus
Exposure Mode	Auto/Manual/Shutter Priority, Aperture Priority, Brightness Priority
Iris	OFF、F11.0、F9.6、F8.0、F6.8、F5.6、F4.8、F4.0、F3.4、F2.8、F2.4、F2.0、F1.8 (Valid only in manual, aperture priority mode)
Electronic Shutter	1/25、1/30、1/50、1/60、1/90、1/100、1/120、1/180、1/250、1/350、1/500、1/1000、1/2000、1/3000、1/4000、1/6000、1/10000 (Only valid in manual, shutter priority mode)
BLC	ON/OFF
WDR	OFF、1~8
Video Adjustment	Brightness, Color, Saturation, Contrast, Sharpness, B/W mode, Gamma curve
SNR	≥50dB
Input/Output Interface	
Video Interfaces	HDMI、LAN(POE&NDI optional)、USB3.0、LINE-IN、5 Pin Phoenix terminal(RS232/RS485)、DC12V Power Supply、Power Switch
Video Output	HDMI, LAN,USB3.0
Video Stream	Dual stream output
Video Bitrate	64Kbps~40960Kbps
Video Compression Format	LAN: H.264、H.265 USB 3.0: MJPG、H264、YUY2、NV12
Audio Input Interface	Double track 3.5mm linear input
Audio Output Interface	HDMI, USB 3.0, LAN
Audio Compression Format	AAC
Audio Bitrate	32Kbps, 48Kbps, 64Kbps, 96Kbps, 128Kbps
Network Interface	100M Ethernet port (10/100BASE-TX)
Control Interface	RS232/RS485

Control Protocol	VISCA/Pelco-D/Pelco-P, Baud Rate: 115200/38400/9600/4800/2400bps
Power Interface	HEC3800 outlet (DC12V)
Power Supply	Input AC110V-AC220V; Output DC12V/2.0A
Input Voltage	DC12V±10%
Input Current	Maximum: 1A
Power Consumption	Maximum: 12W
Network Protocols	TCP/IP, RTSP, RTMP, VISCA OVER IP, IP VISCA, RTMPS, SRT, NDI, ONVIF, GB/T28181; Support Network VISCA control protocol; Support remote upgrade, reboot and reset
PTZ Parameter	
Pan/Tilt Rotation	±170°, -30°~+90°
Pan Control Speed	0.1°/s~100°/s
Tilt Control Speed	0.1°/s~45°/s
Preset Speed	Pan: 100°/sec, Tilt: 45°/sec
Preset Accuracy	±0.1°
Preset Number	255 presets (10 presets via remote control)
Other Parameter	
Stored Temperature	-10°C~+70°C
Stored Humidity	20%~95%
Working Temperature	-10°C~+50°C
Working Humidity	20%~80%
Dimension	253.5mm×144mm×169mm
Weight	1.46KG
Accessory	
Package	Power Supply, RS232 Control Cable, IR Remote Control, User Manual, USB Cable
Optional Accessories	Ceiling / wall Mount (Extra Cost)

3. Remote Control

3.1 Keys Introduction for IR Remote Control

After camera starts normally, it receives and executes the infrared command, press the button of the remote control, the remote control receiving indicator light flashes green, release the button, the indicator light stops flashing. You can use the infrared remote control to perform operations such as preset position setting, positioning, leveling, and tilting.

- 1). In this manual, “press the key” means a click rather than a long-press, and a special note will be given if a long-press for more than one second is required.
- 2). When a key-combination is required, do it in sequence. For example, “ **【*】** + **【#】** + **【F1】** ” means press “ **【*】** ” first and then press “ **【#】** ” and last press “ **【F1】** ” .

1. Standby Key

The camera enters standby mode if long press 3s on standby key;

Long press 3s again on the standby key, the camera will self-check again and return to HOME position (If preset 0 position is set, the camera will return to preset 0 position without operation within 12s).

2. Camera Selection

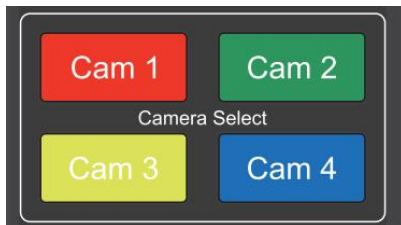

Select the camera address to control.

3. Focus Control

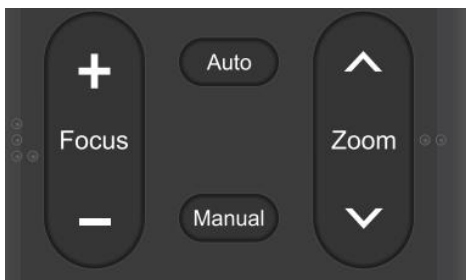

Auto: auto focus mode

Manual: manual focus mode

Focus + (near): Press **【FOCUS +】** key (Valid only in manual focus mode)

Focus - (far): Press **【FOCUS -】** key (Valid only in manual focus mode)

Press and hold the keys, the action of focus will keep continue and stop as soon as the key is released.

4. Zoom Control

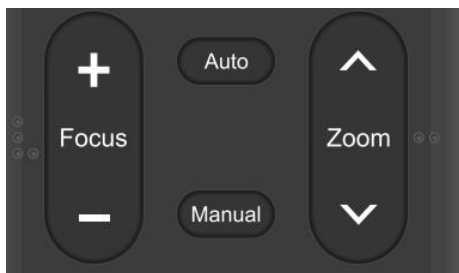

ZOOM +: press **【ZOOM ^】** key to zoom in

ZOOM -: press **【ZOOM v】** key to zoom out

Press and hold the keys, the action of focus will keep continue and stop as soon as the key is released.

5. Set and Clear Presets

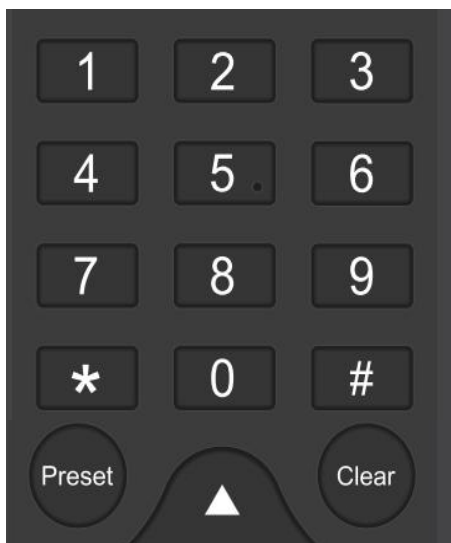

Set Preset: press **【PRESET】** button, and then press the number key 0-9 to set preset positions.

Note: 10 presets via remote control.

Call Preset: Press a number key 0-9 directly to call a preset position.

Note: If the number key is not preset, it is invalid.

Clear Preset: press **【CLEAR】** button, and then press the number key 0-9 to clear preset positions.

Note : press the **【#】** key three times continually to clear all presets.

6. Auto Tracking Buttons

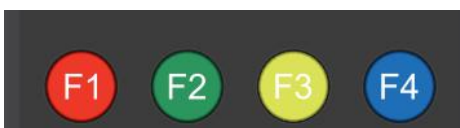

F1: Turn off auto tracking

F2: Turn on auto tracking

F3: Switch auto tracking modes

F4: Switch auto tracking to follow a different person

7. Pan/Tilt Control



Up: press ▲ Down: press ▼
 Left: press ◀ Right: press ▶
 Back to middle position: press“ 【HOME】 ”

Press and hold the up/down/left/right key, the pan/tilt movements will keep running, from slow to fast, until it runs to the endpoint; stop as soon as the key is released.

8. Menu Setting



【MENU】 : Open / close the OSD menu
【HOME】 : Camera lens back to the middle position;
 Confirm button; Enter next menu
【↑】 【↓】 : Choose item
【←】 【→】 : Modify values
【BLC】 : Turn on or off the back light compensation

9. Camera Remote Control Address Setting



【*】 + 【#】 + 【F1】 :Camera Address No.1
【*】 + 【#】 + 【F2】 :Camera Address No. 2
【*】 + 【#】 + 【F3】 :Camera Address No. 3
【*】 + 【#】 + 【F4】 :Camera Address No. 4

10.P/T/Z /Preset Speed Setting

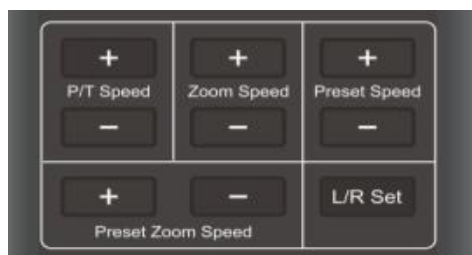

P/T Speed + :Remote Control Pan/Tilt Speed +
 P/T Speed - :Remote Control Pan/Tilt Speed -
 Zoom Speed + :Remote Control Zoom Speed +
 Zoom Speed - :Remote Control Zoom Speed -
 Preset Speed + :Remote Control Preset Speed +
 Preset Speed - :Remote Control Preset Speed -
 Preset Zoom Speed + :Remote Control Preset Zoom Speed +
 Preset Zoom Speed - :Remote Control Preset Zoom Speed -
 L/R Set: Control the forward and reverse rotation of P/T



11. Key Combination

- 1) **【#】 + 【#】 + 【#】** : Clear all presets
- 2) **【*】 + 【#】 + 【6】** : Restore factory defaults
- 3) **【*】 + 【#】 + 【3】** : Menu set to Chinese
- 4) **【*】 + 【#】 + 【4】** : Menu set to English
- 5) **【*】 + 【#】 + 【7】** : Show Camera's current IP address
- 6) **【*】 + 【#】 + 【9】** : Flip switch
- 7) **【*】 + 【#】 + Auto**: Enter aging mode
- 8) **【#】 + 【*】 + Auto**: Exit aging mode
- 9) **【*】 + 【#】 + Manual**: Restore the default user name, password, and enable DHCP
- 10) **【#】 + 【#】 + 【0】** : Switch the video format to 1080P60
- 11) **【#】 + 【#】 + 【1】** : Switch the video format to 1080P50
- 12) **【#】 + 【#】 + 【2】** : Switch the video format to 1080P30
- 13) **【#】 + 【#】 + 【3】** : Switch the video format to 1080P25
- 14) **【#】 + 【#】 + 【4】** : Switch the video format to 720P60
- 15) **【#】 + 【#】 + 【5】** : Switch the video format to 720P50
- 16) **【#】 + 【#】 + 【6】** : Switch the video format to 1080P59.94
- 17) **【#】 + 【#】 + 【7】** : Switch the video format to 1080P29.97
- 18) **【#】 + 【#】 + 【8】** : Switch the video format to 720P59.94

Note: If the address of former remote control is not address 1 but another one from 2, 3, 4, the corresponding camera address will restore to address 1 when all parameters are restored to factory default. User should change the remote control address to address 1.

3.2 Menu Introduction

Note: The modification valid only if exit the menu before save and power off.

1) Menu Control

【MENU】 : Enter / exit the OSD menu or return to the previous menu

【HOME】 : Enter next menu

【↑】 【↓】 : Choose item

【←】 【→】 : Modify values

2) English Menu

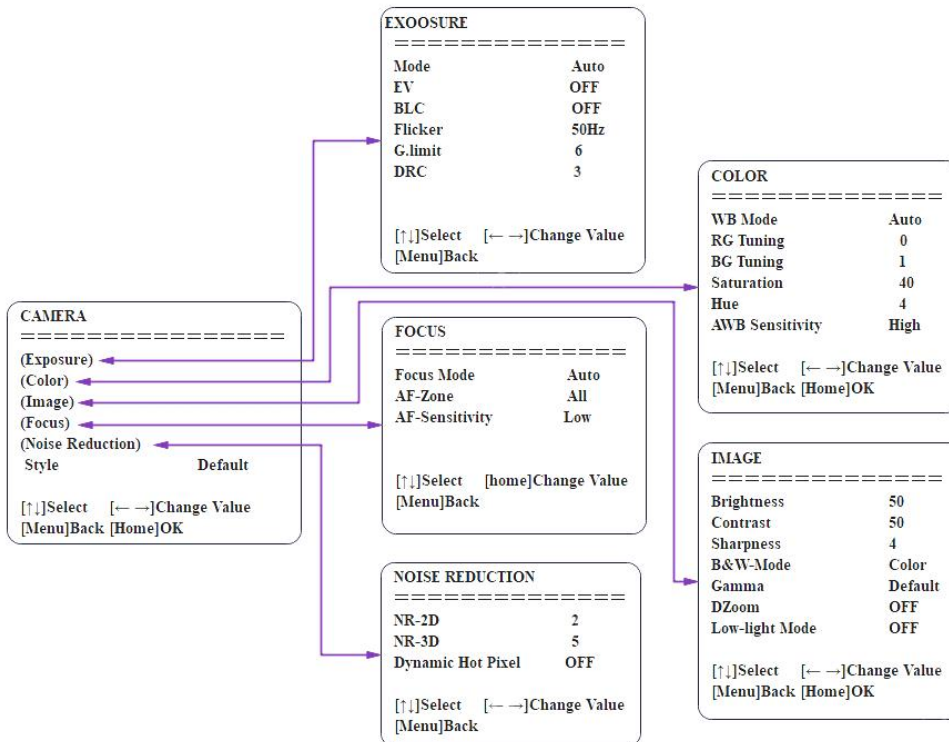
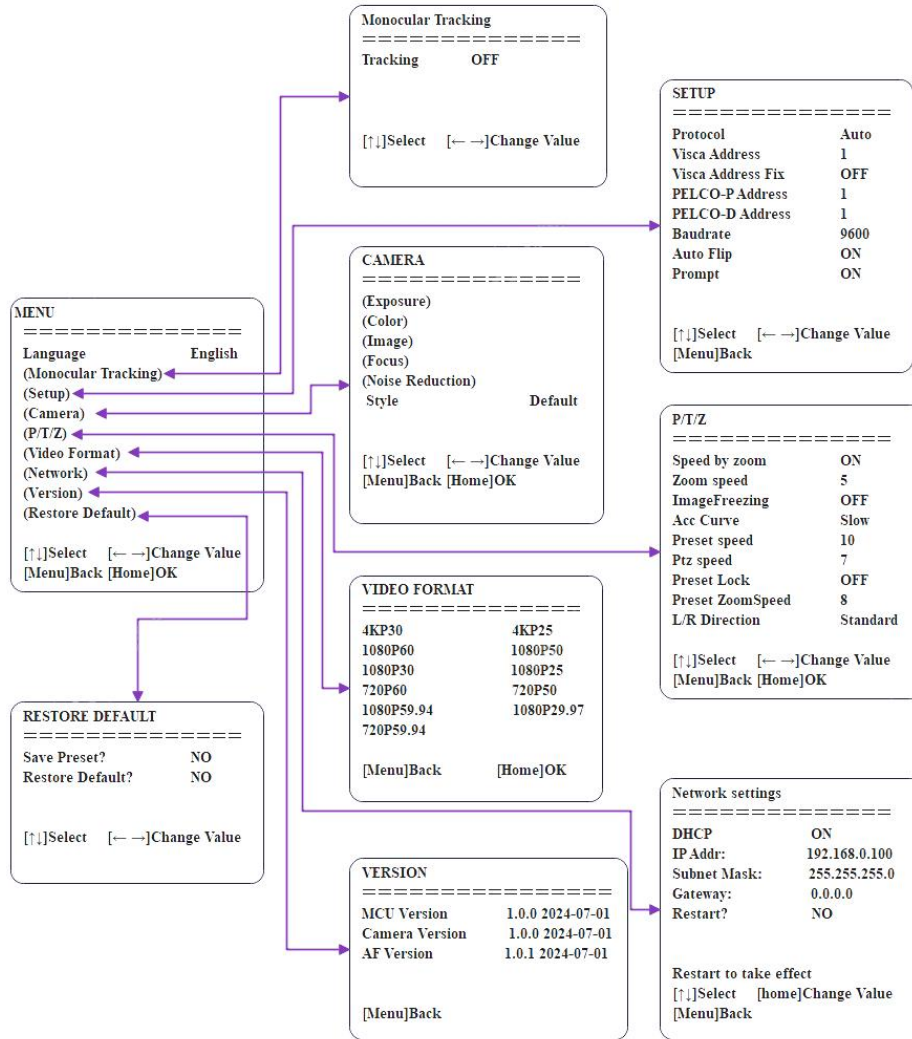

4. Network Configuration

4.1 Network Connection

When you powered on the camera for the first time, please press “* # Manual” one by one on the remote control to restore the camera, it will be more easier to do the following settings.



If you have more than one camera, please restore the cameras one by one:

Power on Cam1, restore Cam1, power off Cam1;

Power on Cam2, restore Cam2, power off Cam2;

Power on Cam3, restore Cam3, power off Cam3;

.....

Now, Please follow the steps to add the camera to your network:

Step 1: Power on the camera

Step 2: Camera HDMI port ->HDMI Cable->TV/monitor-> Camera's video come out on your screen

Step 3: Camera LAN port -> Network Cable- > Router/switch (**which your PC connected to**)

Step 4: Go to camera's menu by press “menu” button on remote control -> Network-> IP Addr.

you can see camera's IP address which assigned by your router. Please check the picture, this camera's IP is 192.168.0.100 (Camera's LCD screen will show the IP address too)

Step 5: Turn “DHCP” to “OFF”, “whether to reset”: YES,

Press “Home” button to confirm the settings on remote control, the camera will reboot.

(Important: turn off DHCP, the camera will keep currently IP address, or when camera reboot, the IP address will be changed.)

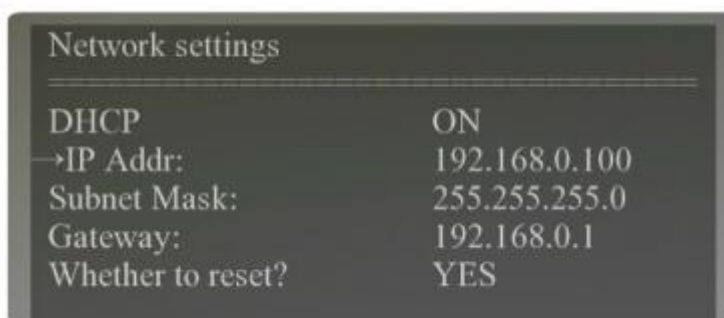

4.2 Web Login

Input the Camera's IP address(example IP: 192.168.0.100) in the browser (Google Chrome recommend) and click Enter button to enter into Web Client login page. User can login as administrator and normal user. If login as administrator (Default User name/Password: admin), users can preview, playback, and set configuration in the Web Client; If login in as normal user (Default User name/Password: user1 or user2), users can only preview, playback

and logout, no option for configuration.

Language Selection: click Chinese/English in the upper right corner of the login page to select the language type of the web interface.

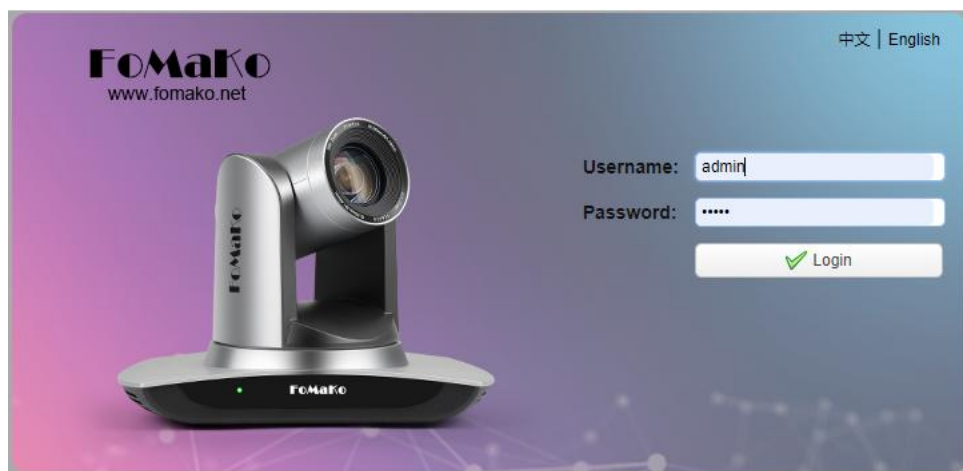

4.3 Streaming

1. Video Stream Capture

1) Configurations -> Video Configure-> Video Encode

Stream	Main Stream	Sub Stream
Compressed Format	H.264	H.264
Profile	HP	HP
Image Size	1920*1080	320*180
Rate Control	CBR	CBR
Image Quality	Best	Better
Bit Rate(Kb/s)	4096	512
Frame Rate(F/S)	30	25
I Frame Interval	90	75
I Frame Min QP	20	20
Stream Name	live/av0	live/av1

Configure the parameters according to the network environment. Note: stream name live/av0 (live/ XXX)

For example:

Camera's example IP is 192.168.0.100. The way to obtain the RTSP video stream is as below

rtsp://192.168.0.100:554/live/av0 (av0 main stream)

rtsp://192.168.0.100:554/live/av1 (av1 sub stream)

Camera's example IP is 192.168.0.100. the way to obtain RTMP video stream is as below

rtmp://192.168.0.100:1935/live/av0 (av0 main stream)

rtmp://192.168.0.100:1935/live/av1 (av1 sub stream)

2) Configurations > Network Configure> SRT

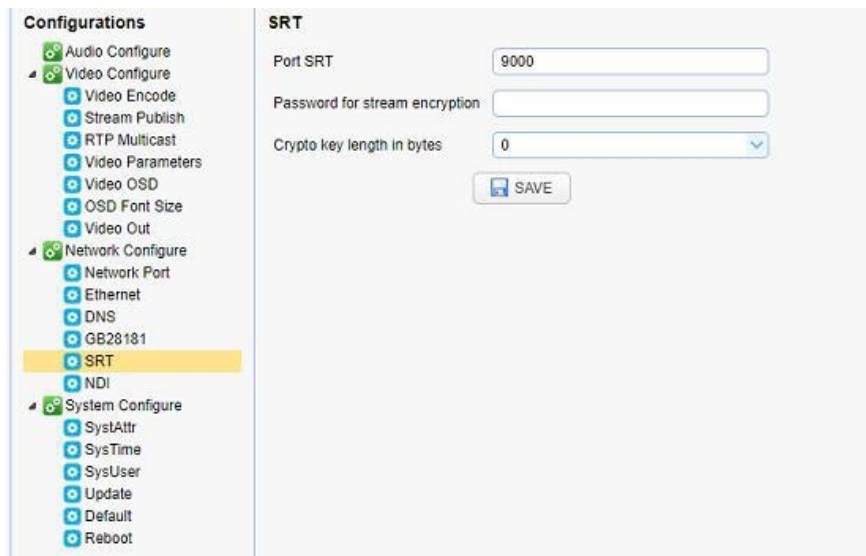

Configure the parameters according to the network environment; Camera’s example IP is 192.168.0.100, and the way to obtain the SRT video stream is as follows: **srt://192.168.0.100:9000**

2. Push Video Stream

Configurations -> Video Configure-> Stream Publish

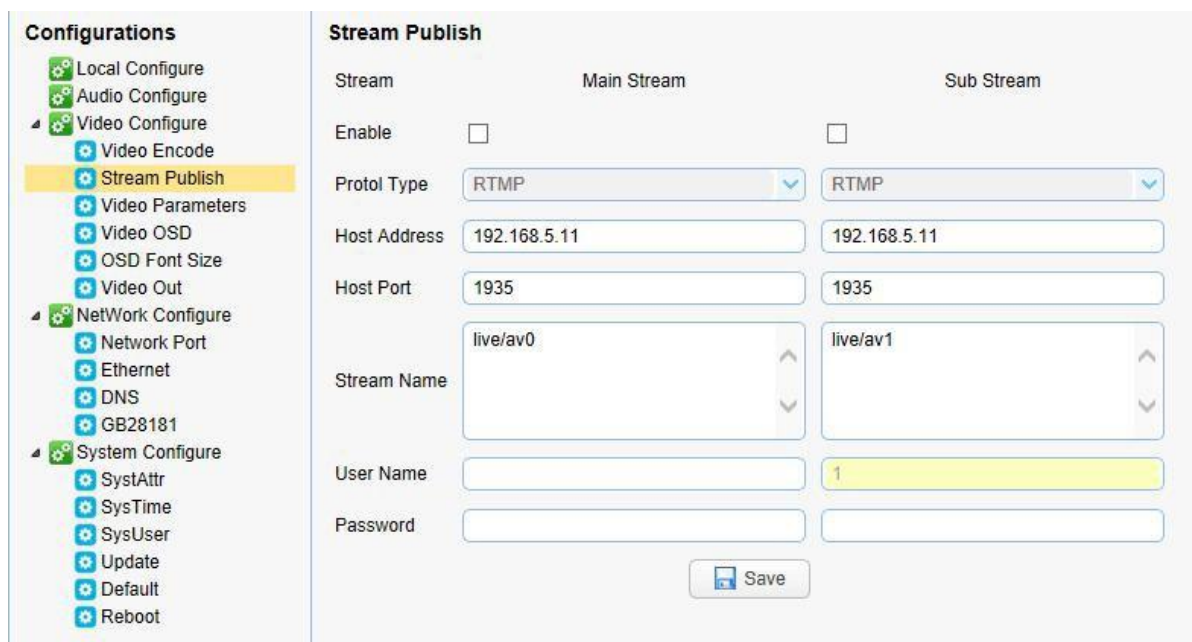

Push RTMP stream to public network server, the stream camera IP must be on the public network, otherwise it will fail to connect to server.

Host address: server address, which can be either a domain name or an IP address

Host port: server default port number

Stream name: live/test (live/ XXX)

Username and password: the username and password set by the server, or leave it empty

Access url: `rtmp://host domain name: host port/live/xxx`

Or (rtmp: //host IP address: host port/live/xxx)

4.4 Software Upgrading

1) Log in to the web page and manage camera settings. The default page is preview interface, where users can PTZ control, record video, preset camera positions and etc.

2) Configurations -> System Configure-> Update

Configurations

- Local Configure
- Audio Configure
- Video Configure
 - Video Encode
 - Stream Publish
 - Video Parameters
 - Video OSD
 - OSD Font Size
 - Video Out
- Network Configure
 - Network Port
 - Ethernet
 - DNS
 - GB28181
- System Configure
 - SystAttr
 - SysTime
 - SysUser
 - Update**
 - Default
 - Reboot

Release Upgrade

MCU Version V2.2.5 2016-10-25

Camera Version V2.2.6 2016-10-20

AF Version V2.4.3 2016-10-20

Update File 浏览...

Upgrade

3) Click "browse" to select .mrg update file, then click upgrade button to finish software upgrading.

4) Camera reboot after completion of firmware update. It prompts with "successful upgrade".

Log in to check the firmware version to make sure software upgrade successful.

Then click "restore factory default", reboot and restore parameters to factory default (user name: admin; password admin).

4.5 Monocular Tracking:

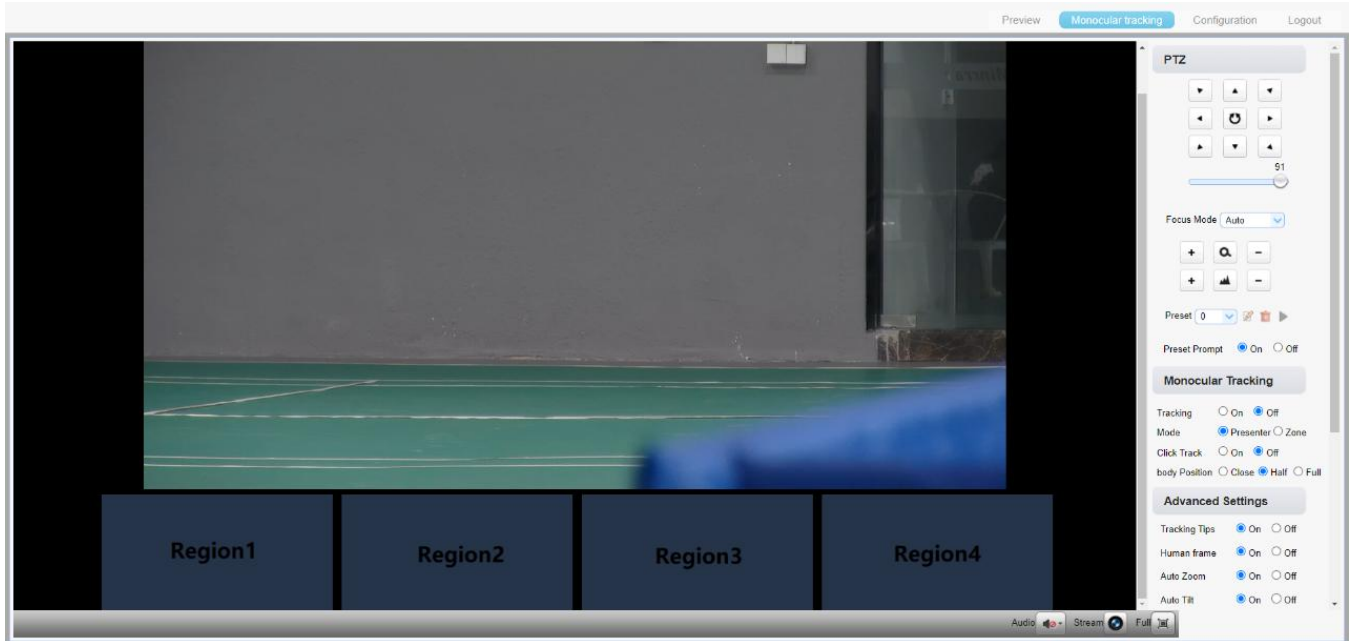

Preset Prompt: After turning on, the upper left corner of the television screen will display information such as settings, deletion, and calling of preset positions.

1.Real-time Tracking:

Tracking: Switch

Mode: Area Tracking and Real-time Tracking Switching

Click Track: During the tracking process, the tracking target can be switched by pressing the F4 key on the remote control; available in real-time tracking mode.

Body position: Indicates the position of the tracked target's head in the frame; available in real-time tracking mode.

Tracking Tips: When enabled, tracking information is displayed in the upper left corner of the TV screen, such as switching tracking targets, tracking modes, and enabling/disabling tracking; available in area tracking and real-time tracking modes.

Human frame: When enabled, a bounding box appears around the tracked target in the frame; available in area tracking and real-time tracking modes.

Auto zoom: When enabled, limits the lens zoom; available in real-time tracking mode.

Auto Tilt: When enabled, restricts the vertical movement of the pan-tilt unit; available in real-time tracking mode.

Lost reaction:stay/home, Determines the camera's action when the tracked target is lost.

Setting Tips: “Turn off autoscaling or autotilt and zoom/vertical will not change, determining the zoom size and tilt position based on the starting position of the selected tracking.”

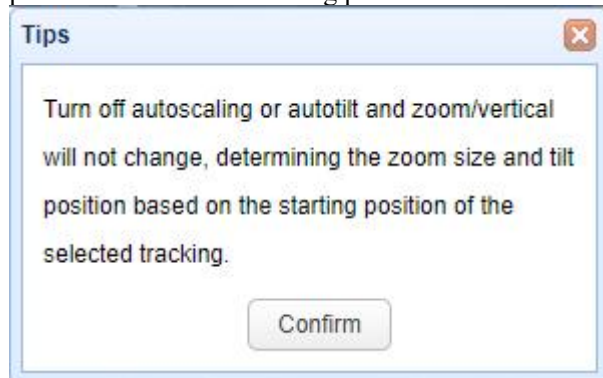

2.Area Tracking:

Area Tracking Mode: Enable area tracking mode to perform area tracking

Setting up the Area: To set up area tracking (using Area 1 as an example), navigate to the pan-tilt control interface and adjust the frame to select the desired tracking area for Area 1. Press the setup button to complete the configuration for tracking Area 1. Repeat the same process for other tracking areas.

You can set up to 4 different tracking areas, with a minimum of 2 areas required. Area tracking settings can only be configured through the web interface.

Using Area Tracking Presets: Click on the preset area number to preview and activate the pre-set tracking area for monitoring.

⚠ Caution

- When tracking is enabled, the pan-tilt becomes uncontrollable. Each preset view in area tracking must be continuous from left to right and overlap when setting presets.

1. Each preset preview image must be continuous from left to right and overlap when setting the tracking regions.

2. You need to tick next to the region number to save the setting location when you setting the region.

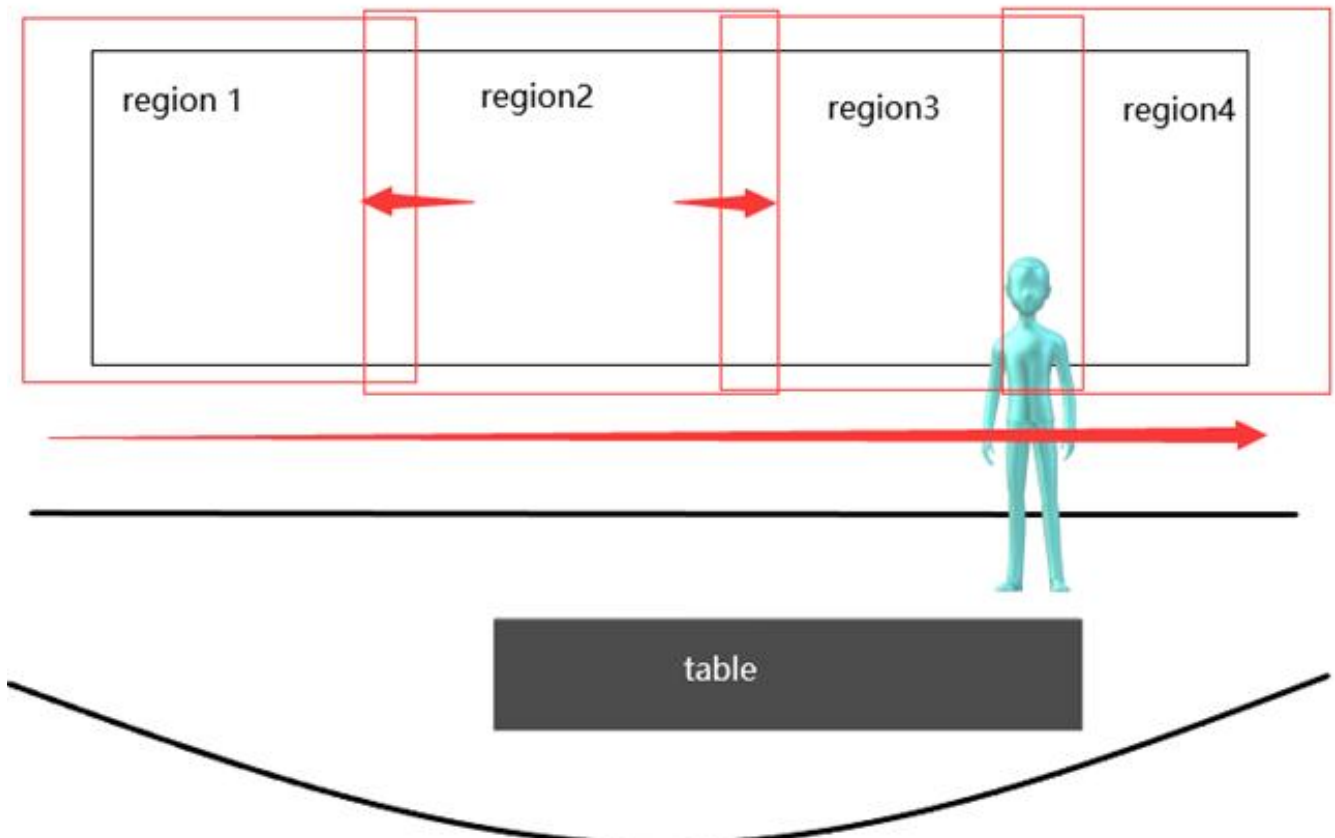

Area Tracking Setup Guide

5. Serial Port Communication and Control

The camera could be controlled through RS232/RS485/RS422 interface; RS232 serial parameter are as follows:
Baud rate: 2400/4800/9600/115200 bits / sec; Start bit: 1; data bits: 8; Stop bit: 1; Parity: None.

After power on, the camera first goes left, then back to the middle position. Self-test is finished after the zoom moved to the farthest and then back to the nearest position. If the camera saved 0 preset before, it will be back to that position after initialization. At this point, the user can control the camera by the serial commands.

5.1 VISCA Protocol Return Command

Ack/Completion Message		
	Command Packet	Note
ACK	z0 41 FF	Returned when the command is accepted.
Completion	z0 51 FF	Returned when the command has been executed.

z = camera address + 8

Error Messages		
	Command Packet	Note
Syntax Error	z0 60 02 FF	Returned when the command format is different or when a command with illegal command parameters is accepted
Command Not Executable	z0 61 41 FF	Returned when a command cannot be executed due to current conditions. For example, when commands controlling the focus manually are received during auto focus.

5.2 VISCA Protocol Control Command

Command	Function	Command Packet	Note
AddressSet	Broadcast	88 30 0p FF	p: Address setting
IF_Clear	Broadcast	88 01 00 01 FF	I/F Clear
CAM_Power	On	8x 01 04 00 02 FF	Power ON/OFF
	Off	8x 01 04 00 03 FF	
CAM_Zoom	Stop	8x 01 04 07 00 FF	p = 0(low) - F(high) pqrs: Zoom Position
	Tele(Standard)	8x 01 04 07 02 FF	
	Wide(Standard)	8x 01 04 07 03 FF	
	Tele(Variable)	8x 01 04 07 2p FF	
	Wide(Variable)	8x 01 04 07 3p FF	
	Direct	8x 01 04 47 0p 0q 0r 0s FF	
CAM_Focus	Stop	8x 01 04 08 00 FF	p = 0(low) - F(high) pqrs: Focus Position
	Far(Standard)	8x 01 04 08 02 FF	
	Near(Standard)	8x 01 04 08 03 FF	
	Far(Variable)	8x 01 04 08 2p FF	
	Near (Variable)	8x 01 04 08 3p FF	
	Direct	8x 01 04 48 0p 0q 0r 0s FF	
	Auto Focus	8x 01 04 38 02 FF	
	Manual Focus	8x 01 04 38 03 FF	
One Push mode	8x 01 04 38 04 FF		
CAM_Zoom Focus	Direct	8x 01 04 47 0p 0q 0r 0s 0t 0u 0v 0w FF	pqrs: Zoom Position tuvw: Focus Position
	High	8x 01 04 58 01 FF	

Command	Function	Command Packet	Note
CAM_AFSensitivity	Normal	8x 01 04 58 02 FF	Focus sensitivity Setting
	Low	8x 01 04 58 03 FF	
CAM_AFZone	Top	8x 01 04 AA 00 FF	Focus Region Setting
	Center	8x 01 04 AA 01 FF	
	Bottom	8x 01 04 AA 02 FF	
	All	8x 01 04 AA 03 FF	
	All	8x 01 04 AA 04 FF	
	All	8x 01 04 AA 05 FF	
CAM_WB	One Push mode	8x 01 04 35 03 FF	One Push WB Trigger(Enabled during One Push WB mode) pq = 00--0B WMode
	One Push Trigger	8x 01 04 10 05 FF	
	CAM_WB Mode	8x 01 04 35 pq FF	
CAM_AWBSensitivity	Low	8x 01 04 A9 00 FF	WB Sensitivity Setting
	Normal	8x 01 04 A9 01 FF	
	High	8x 01 04 A9 02 FF	
CAM_RGain	Reset	8x 01 04 03 00 FF	Manual Control of R Gain
	Up	8x 01 04 03 02 FF	
	Down	8x 01 04 03 03 FF	
	Direct	8x 01 04 43 00 00 0p 0q FF	pq: R Gain
CAM_BGain	Reset	8x 01 04 04 00 FF	Manual Control of B Gain
	Up	8x 01 04 04 02 FF	
	Down	8x 01 04 04 03 FF	
	Direct	8x 01 04 44 00 00 0p 0q FF	pq: B Gain
CAM_AE	Full Auto	8x 01 04 39 00 FF	Automatic Exposure mode
	Manual	8x 01 04 39 03 FF	Manual Control mode
	Shutter priority	8x 01 04 39 0A FF	Shutter Priority Automatic Exposure mode
	Iris priority	8x 01 04 39 0B FF	Iris Priority Automatic Exposure mode
	Bright	8x 01 04 39 0D FF	Bright mode
CAM_Shutter	Reset	8x 01 04 0A 00 FF	Shutter Setting
	Up	8x 01 04 0A 02 FF	
	Down	8x 01 04 0A 03 FF	
	Direct	8x 01 04 4A 00 00 0p 0q FF	pq: Shutter Position
CAM_Iris	Reset	8x 01 04 0B 00 FF	Iris Setting
	Up	8x 01 04 0B 02 FF	
	Down	8x 01 04 0B 03 FF	
	Direct	8x 01 04 4B 00 00 0p 0q FF	pq: Iris Position
CAM_Gain Limit	Reset	8x 01 04 0C 00 FF	Gain Limit Setting
	Up	8x 01 04 0C 02 FF	
	Down	8x 01 04 0C 03 FF	
	Gain Limit	8x 01 04 2C 0p FF	p: Gain Positon
CAM_Bright	Reset	8x 01 04 0D 00 FF	Bright Setting
	Up	8x 01 04 0D 02 FF	
	Down	8x 01 04 0D 03 FF	
	Direct	8x 01 04 4D 00 00 0p 0q FF	pq: Bright Positon
CAM_ExpComp	On	8x 01 04 3E 02 FF	Exposure Compensation ON/OFF
	Off	8x 01 04 3E 03 FF	
	Reset	8x 01 04 0E 00 FF	Exposure Compensation Amount Setting
	Up	8x 01 04 0E 02 FF	
	Down	8x 01 04 0E 03 FF	
	Direct	8x 01 04 4E 00 00 0p 0q FF	pq: ExpComp Position

Command	Function	Command Packet	Note
CAM_Back Light	On	8x 01 04 33 02 FF	Back Light Compensation
	Off	8x 01 04 33 03 FF	
CAM_WDRStrength	Reset	8x 01 04 21 00 FF	WDR Level Setting
	Up	8x 01 04 21 02 FF	
	Down	8x 01 04 21 03 FF	
	Direct	8x 01 04 51 00 00 00 0p FF	p: WDR Level Positon
CAM_NR	2D	8x 01 04 53 0p FF	P=0-7 0:OFF
	3D	8x 01 04 54 0p FF	P=0-8 0:OFF
CAM_Gamma		8x 01 04 5B 0p FF	p = 0 – 4 0:Default 1: 0.45 2:0.50 3:0.55 4:0.63
CAM_Low-Light Mode	ON	8x 01 04 2D 01 FF	Low-Light Mode Setting
	OFF	8x 01 04 2D 00 FF	
CAM_Flicker	OFF	8x 01 04 23 00 FF	OFF
	50HZ	8x 01 04 23 01 FF	50HZ
	60HZ	8x 01 04 23 02 FF	60HZ
CAM_Aperture	Reset	8x 01 04 02 00 FF	Aperture Control
	Up	8x 01 04 02 02 FF	
	Down	8x 01 04 02 03 FF	
	Direct	8x 01 04 42 00 00 0p 0q FF	pq: Aperture Gain
CAM_PictureEffect	B&W-Mode	8x 01 04 63 04 FF	PictureEffect Setting
	OFF	8x 01 04 63 00 FF	
CAM_Memory	Reset	8x 01 04 3F 00 pq FF	pq: Memory Number(=0 to 254) Corresponds to 0 to 9 on the Remote Commander
	Set	8x 01 04 3F 01 pq FF	
	Recall	8x 01 04 3F 02 pq FF	
CAM_LR_Reverse	On	8x 01 04 61 02 FF	Image Flip Horizontal ON/OFF
	Off	8x 01 04 61 03 FF	
CAM_PictureFlip	On	8x 01 04 66 02 FF	Image Flip Vertical ON/OFF
	Off	8x 01 04 66 03 FF	
CAM_ColorSaturation	Direct	8x 01 04 49 00 00 00 0p FF	P=0-7E
CAM_IDWrite		8x 01 04 22 0p 0q 0r 0s FF	pqrs: Camera ID (=0000 to FFFF)
Preset Lock	ON	8x 01 03 02 FF	Preset Lock ON/OFF
	OFF	8x 01 03 03 FF	
Pan Tilt Speed	Set Pan Tilt Speed	8x 01 02 0p FF	P:1-10
SYS_Menu	ON	8x 01 06 06 02 FF	Turn on the menu screen
	OFF	8x 01 06 06 03 FF	Turn off the menu screen
IR_Receive	ON	8x 01 06 08 02 FF	IR(remote commander)receive On/Off
	OFF	8x 01 06 08 03 FF	
IR_ReceiveReturn	On	8x 01 7D 01 03 00 00 FF	IR(remote commander)receive message via the VISCA communication ON/OFF
	Off	8x 01 7D 01 13 00 00 FF	
CAM_SettingReset	Reset	8x 01 04 A0 10 FF	Reset Factory Setting
CAM_Brightness	Direct	8x 01 04 A1 00 00 0p 0q FF	pq: Brightness Position
CAM_Contrast	Direct	8x 01 04 A2 00 00 0p 0q FF	pq: Contrast Position
CAM_Flip	OFF	8x 01 04 A4 00 FF	Single Command For Video Flip
	Flip-H	8x 01 04 A4 01 FF	
	Flip-V	8x 01 04 A4 02 FF	
	Flip-HV	8x 01 04 A4 03 FF	
			P: Video format 0:1080P60;

Command	Function	Command Packet	Note
CAM_VideoSystem	Set camera video system	8x 01 06 35 00 0p FF	1:1080P50; 4:720P60; 5:720P50; 6:1080P30; 7:1080P25; A:1080P59.94; C:720P59.94; D:1080P29.97;
Pan_tiltDrive	Up	8x 01 06 01 VV WW 03 01 FF	VV: Pan speed 0x01 (low speed) to 0x18 (high speed) WW: Tilt speed 0x01 (low speed) to 0x14 (high speed) YYYY: Pan Position ZZZZ: Tilt Position
	Down	8x 01 06 01 VV WW 03 02 FF	
	Left	8x 01 06 01 VV WW 01 03 FF	
	Right	8x 01 06 01 VV WW 02 03 FF	
	Upleft	8x 01 06 01 VV WW 01 01 FF	
	Upright	8x 01 06 01 VV WW 02 01 FF	
	DownLeft	8x 01 06 01 VV WW 01 02 FF	
	DownRight	8x 01 06 01 VV WW 02 02 FF	
	Stop	8x 01 06 01 VV WW 03 03 FF	
	AbsolutePosition	8x 01 06 02 VV WW 0Y 0Y 0Y 0Y 0Z 0Z 0Z 0Z FF	
	RelativePosition	8x 01 06 03 VV WW 0Y 0Y 0Y 0Y 0Z 0Z 0Z 0Z FF	
	Home	8x 01 06 04 FF	
	Reset	8x 01 06 05 FF	
Pan-tiltLimitSet	Set	8x 01 06 07 00 0W 0Y 0Y 0Y 0Y 0Z 0Z 0Z 0Z FF	W:1 UpRight 0:DownLeft YYYY: Pan Limit Position(TBD) ZZZZ: Tilt Limit Position(TBD)
	Clear	8x 01 06 07 01 0W 07 0F 0F 0F 07 0F 0F 0F FF	
Tracking	Tracking OFF	81 0A 01 32 00 00 03 00 FF	Tracking OFF/ON
	Tracking ON	81 0A 01 32 00 00 02 00 FF	
	Real time tracking mode	81 0A 01 32 00 00 02 00 FF	
	zone tracking mode	81 0A 01 32 00 00 02 01 FF	

5.3 VISCA Protocol Inquiry Command

Command	Command Packet	Return Packet	Note
CAM_PowerInq	8x 09 04 00 FF	y0 50 02 FF	On
		y0 50 03 FF	Off(Standby)
CAM_ZoomPosInq	8x 09 04 47 FF	y0 50 0p 0q 0r 0s FF	pqrs: Zoom Position
CAM_FocusAFModeInq	8x 09 04 38 FF	y0 50 02 FF	Auto Focus
		y0 50 03 FF	Manual Focus
		y0 50 04 FF	One Push mode
CAM_FocusPosInq	8x 09 04 48 FF	y0 50 0p 0q 0r 0s FF	pqrs: Focus Position
CAM_AFSensitivityInq	8x 09 04 58 FF	y0 50 01 FF	High
		y0 50 02 FF	Normal
		y0 50 03 FF	Low
CAM_AFZoneInq	8x 09 04 AA FF	y0 50 00 FF	Front
		y0 50 01 FF	Beting
		y0 50 02 FF	Meeting
		y0 50 03 FF	Education
		y0 50 04 FF	Moving
		y0 50 05 FF	Middle
CAM_WPModeInq	8x 09 04 35 FF	y0 50 00 FF	Auto

Command	Command Packet	Return Packet	Note
		y0 50 01 FF	3000K
		y0 50 02 FF	4000K
		y0 50 03 FF	One Push Mode
		y0 50 04 FF	5000K
		y0 50 05 FF	Manual
		y0 50 06 FF	6500K
		y0 50 07 FF	3500K
		y0 50 08 FF	4500K
		y0 50 09 FF	5500K
		y0 50 0A FF	6000K
		y0 50 0B FF	7000K
CAM_AWBSensitivityInq	8x 09 04 A9 FF	y0 50 00 FF	Low
		y0 50 01 FF	Normal
		y0 50 02 FF	High
CAM_RGainInq	8x 09 04 43 FF	y0 50 00 00 0p 0q FF	pq: R Gain
CAM_BGainInq	8x 09 04 44 FF	y0 50 00 00 0p 0q FF	pq: B Gain
CAM_AEModeInq	8x 09 04 39 FF	y0 50 00 FF	Full Auto
		y0 50 03 FF	Manual
		y0 50 0A FF	Shutter priority
		y0 50 0B FF	Iris priority
		y0 50 0D FF	Bright
CAM_ShutterPosInq	8x 09 04 4A FF	y0 50 00 00 0p 0q FF	pq: Shutter Position
CAM_IrisPosInq	8x 09 04 4B FF	y0 50 00 00 0p 0q FF	pq: Iris Position
CAM_GainLimitInq	8x 09 04 2C FF	y0 50 0p FF	p: Gain Positon
CAM_BrightPosInq	8x 09 04 4D FF	y0 50 00 00 0p 0q FF	pq: Bright Position
CAM_ExpCompModeInq	8x 09 04 3E FF	y0 50 02 FF	On
		y0 50 03 FF	Off
CAM_ExpCompPosInq	8x 09 04 4E FF	y0 50 00 00 0p 0q FF	pq: ExpComp Position
CAM_BacklightModeInq	8x 09 04 33 FF	y0 50 02 FF	On
		y0 50 03 FF	Off
CAM_WDRStrengthInq	8x 09 04 51 FF	y0 50 0p FF	p: WDR Strength
CAM_NRLevel(2D) Inq	8x 09 04 53 FF	y0 50 0p FF	P: 2DNRLLevel
CAM_NRLevel(3D) Inq	8x 09 04 54 FF	y0 50 0p FF	P:3D NRLevel
CAM_FlickerModeInq	8x 09 04 55 FF	y0 50 0p FF	p: Flicker Settings(0: OFF, 1: 50Hz, 2:60Hz)
CAM_ApertureInq	8x 09 04 42 FF	y0 50 00 00 0p 0q FF	pq: Aperture Gain
CAM_PictureEffectModeInq	8x 09 04 63 FF	y0 50 00 FF	Off
		y0 50 04 FF	B&W
CAM_MemoryInq	8x 09 04 3F FF	y0 50 0p FF	p: Memory number last operated.
Pan Tilt SpeedInq	8x 09 01 01 FF	y0 50 0p FF	P:1-10
SYS_MenuModeInq	8x 09 06 06 FF	y0 50 02 FF	On
		y0 50 03 FF	Off
CAM_LR_ReverseInq	8x 09 04 61 FF	y0 50 02 FF	On
		y0 50 03 FF	Off
CAM_PictureFlipInq	8x 09 04 66 FF	y0 50 02 FF	On
		y0 50 03 FF	Off
CAM_ColorSaturationInq	8x 09 04 49 FF	y0 50 00 00 00 0p FF	p: Color Gain setting 00 (0) to 7F(127)
CAM_IDInq	8x 09 04 22 FF	y0 50 0p FF	p: Gamma ID
IR_ReceiveInq	8x 09 06 08 FF	y0 50 02 FF	On
		y0 50 03 FF	Off
IR_ReceiveReturn		y0 07 7D 01 04 00 FF	Power ON/OFF
		y0 07 7D 01 04 07 FF	Zoom tele/wide
		y0 07 7D 01 04 38 FF	AF ON/OFF
		y0 07 7D 01 04 33 FF	Camera Backlight
		y0 07 7D 01 04 3F FF	Camera Memery
		y0 07 7D 01 06 01 FF	Pan titleDriver
CAM_BrightnessInq	8x 09 04 A1 FF	y0 50 00 00 0p 0q FF	pq: Brightness Position
CAM_ContrastInq	8x 09 04 A2 FF	y0 50 00 00 0p 0q FF	pq: Contrast Position
CAM_FlipInq	8x 09 04 A4 FF	y0 50 00 FF	Off
		y0 50 01 FF	Flip-H
		y0 50 02 FF	Flip-V
		y0 50 03 FF	Flip-HV
CAM_GammaInq	8x 09 04 5B FF	y0 50 0p FF	p: Gamma setting
CAM_Low-LightModeInq	8x 09 04 2D FF	y0 50 00 FF	OFF

Command	Command Packet	Return Packet	Note
		y0 50 01 FF	ON
CAM_VersionInq	8x 09 00 02 FF	y0 50 ab cd mn pq rs tu vw FF	ab cd : vender ID (0220) mn pq : model ID rs tu :ARM Version vw: reserve
VideoSystemInq	8x 09 06 23 FF	y0 50 0p FF	P: Video format 0:1080P60; 1:1080P50; 4:720P60; 5:720P50; 6:1080P30; 7:1080P25; A:1080P59.94; C:720P59.94; D:1080P29.97;
Pan-tiltMaxSpeedInq	8x 09 06 11 FF	y0 50 ww zz FF	ww: Pan Max Speed zz: Tilt Max Speed
Pan-tiltPosInq	8x 09 06 12 FF	y0 50 0w 0w 0w 0w 0z 0z 0z 0z FF	www: Pan Position zzzz: Tilt Position

Note:[X] in the above table indicates the camera address to be operated, **【y】 = 【x + 8】** .

5.4 Pelco-D Protocol Command List

Function	Byte1	Byte2	Byte3	Byte4	Byte5	Byte6	Byte7
Up	0xFF	Address	0x00	0x08	Pan Speed	Tilt Speed	SUM
Down	0xFF	Address	0x00	0x10	Pan Speed	Tilt Speed	SUM
Left	0xFF	Address	0x00	0x04	Pan Speed	Tilt Speed	SUM
Right	0xFF	Address	0x00	0x02	Pan Speed	Tilt Speed	SUM
Upleft	0xFF	Address	0x00	0x0C	Pan Speed	Tilt Speed	SUM
Upright	0xFF	Address	0x00	0x0A	Pan Speed	Tilt Speed	SUM
DownLeft	0xFF	Address	0x00	0x14	Pan Speed	Tilt Speed	SUM
DownRight	0xFF	Address	0x00	0x12	Pan Speed	Tilt Speed	SUM
Zoom In	0xFF	Address	0x00	0x20	0x00	0x00	SUM
Zoom Out	0xFF	Address	0x00	0x40	0x00	0x00	SUM
Focus Far	0xFF	Address	0x00	0x80	0x00	0x00	SUM
Focus Near	0xFF	Address	0x01	0x00	0x00	0x00	SUM
Stop	0xFF	Address	0x00	0x00	0x00	0x00	SUM
Set Preset	0xFF	Address	0x00	0x03	0x00	Preset ID	SUM
Clear Preset	0xFF	Address	0x00	0x05	0x00	Preset ID	SUM
Call Preset	0xFF	Address	0x00	0x07	0x00	Preset ID	SUM
Query Pan Position	0xFF	Address	0x00	0x51	0x00	0x00	SUM
Query Pan Position Response	0xFF	Address	0x00	0x59	Value High Byte	Value Low Byte	SUM
Query Tilt Position	0xFF	Address	0x00	0x53	0x00	0x00	SUM
Query Tilt Position Response	0xFF	Address	0x00	0x5B	Value High Byte	Value Low Byte	SUM
Query Zoom Position	0xFF	Address	0x00	0x55	0x00	0x00	SUM
Query Zoom Position Response	0xFF	Address	0x00	0x5D	Value High Byte	Value Low Byte	SUM

5.5 Pelco-P Protocol Command List

Function	Byte1	Byte2	Byte3	Byte4	Byte5	Byte6	Byte7	Byte 8
Up	0xA0	Address	0x00	0x08	Pan Speed	Tilt Speed	0xAF	XOR

Down	0xA0	Address	0x00	0x10	Pan Speed	Tilt Speed	0xAF	XOR
Left	0xA0	Address	0x00	0x04	Pan Speed	Tilt Speed	0xAF	XOR
Right	0xA0	Address	0x00	0x02	Pan Speed	Tilt Speed	0xAF	XOR
Upleft	0xA0	Address	0x00	0x0C	Pan Speed	Tilt Speed	0xAF	XOR
Upright	0xA0	Address	0x00	0x0A	Pan Speed	Tilt Speed	0xAF	XOR
DownLeft	0xA0	Address	0x00	0x14	Pan Speed	Tilt Speed	0xAF	XOR
DownRight	0xA0	Address	0x00	0x12	Pan Speed	Tilt Speed	0xAF	XOR
Zoom In	0xA0	Address	0x00	0x20	0x00	0x00	0xAF	XOR
Zoom Out	0xA0	Address	0x00	0x40	0x00	0x00	0xAF	XOR
Stop	0xA0	Address	0x00	0x00	0x00	0x00	0xAF	XOR
Focus Far	0xA0	Address	0x01	0x00	0x00	0x00	0xAF	XOR
Focus Near	0xA0	Address	0x02	0x00	0x00	0x00	0xAF	XOR
Set Preset	0xA0	Address	0x00	0x03	0x00	Preset ID	0xAF	XOR
Clear Preset	0xA0	Address	0x00	0x05	0x00	Preset ID	0xAF	XOR
Call Preset	0xA0	Address	0x00	0x07	0x00	Preset ID	0xAF	XOR
Query Pan Position	0xA0	Address	0x00	0x51	0x00	0x00	0xAF	XOR
Query Pan Position Response	0xA0	Address	0x00	0x59	Value High Byte	Value Low Byte	0xAF	XOR
Query Tilt Position	0xA0	Address	0x00	0x53	0x00	0x00	0xAF	XOR
Query Tilt Position Response	0xA0	Address	0x00	0x5B	Value High Byte	Value Low Byte	0xAF	XOR
Query Zoom Position	0xA0	Address	0x00	0x55	0x00	0x00	0xAF	XOR
Query Zoom Position Response	0xA0	Address	0x00	0x5D	Value High Byte	Value Low Byte	0xAF	XOR

6. Maintenance and Troubleshooting

6.1 Camera Maintenance

- 1) Please power off the camera and disconnect the power adapter and socket, if it's not used for a long run.
- 2) Use soft cloth or tissue to clean the camera cover.
- 3) Wipe it with a soft, dry cloth when cleaning the camera lens. Wipe it gently with a mild detergent if needed. Do not use strong or corrosive detergents to avoid scratching the lens and affecting the video quality.

6.2 Troubleshooting

1) No video output

- a. Check whether the camera power supply is connected, the voltage is normal, the power indicator is lit.
- b. Whether the machine could do self-check after restarted.
- c. Check whether the bottom of the DIP switch is the normal operating mode (see Table 2.2 and Table 2.3)
- d. Check whether the video output cable or video display is normal

2) No image sometimes

- a. Check whether the video output cable or video display is normal

3) Video dithering when zoom-in or zoom-out

- a. Check whether the camera installation position is solid
- b. Whether there is shaking machine or objects around the camera

4) Remote control not works

- a. Remote control address is set to 1 (if the machine is set back to the factory defaults, remote control addresses need to be back to 1 too)
- b. Check whether the battery is installed on the remote controller or low.
- c. Check the menu whether is closed, camera control through remote controller is only available after exiting the menu. If video output from LAN, menu will not be displayed, menu will automatically exists 30s later, and then it can be controlled by remote controller.

5) Serial port not works

- a. Check whether the camera serial device protocol, baud rate, address is consistent
- b. Check whether the control cable is connected properly
- c. Check whether the camera working mode is the normal operating mode

6) Web pages cannot log in

- a. Check if the camera outputs video normally by connecting directly to the screen.
- b. Check whether the network cable is connected properly (Ethernet port yellow light flashes to indicate normal network cable connection)
- c. Check camera's currently IP Address
- d. Check if camera and PC are connected to the same router/

7) How to use the camera as USB camera for skype/zoom

Method One: Use camera's USB port

Method Two: Use HDMI to USB video capture card

8) Can't transmit audio

Please login the camera's webpage -> Configuration-> Audio configure -> Enable then Reboot the camera.

you can also do something audio settings here.

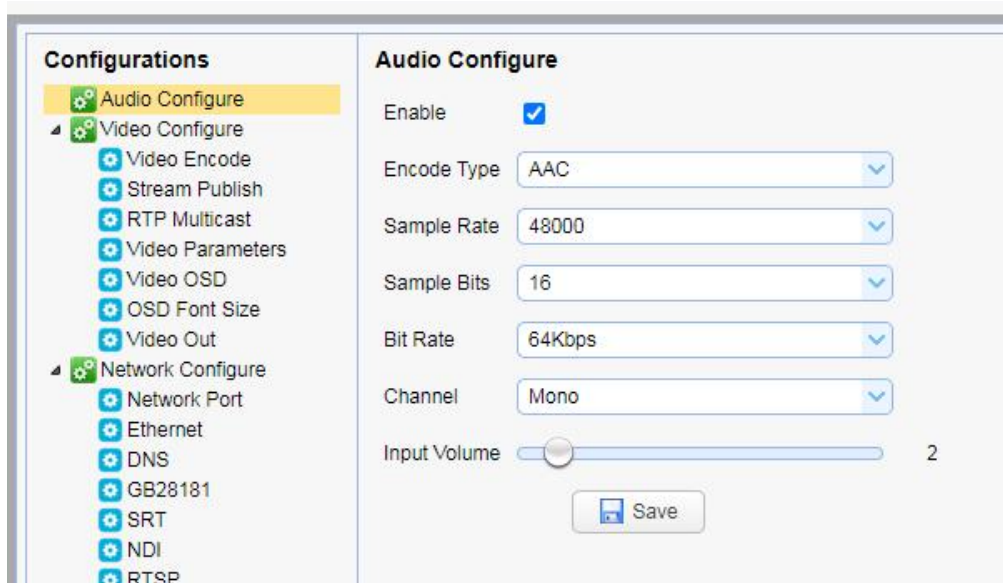

9) Other unknown problems , please email us at: ivan@fomako.net

We will help you to solve all the problems.

7. Example: Streaming to Facebook

Step 1:

First of all, please make sure the camera's IP address is assigned by router, and input your PC's DNS, if you don't your pc's DNS, you can also use Google NDS:

8.8.8.8

8.8.4.4

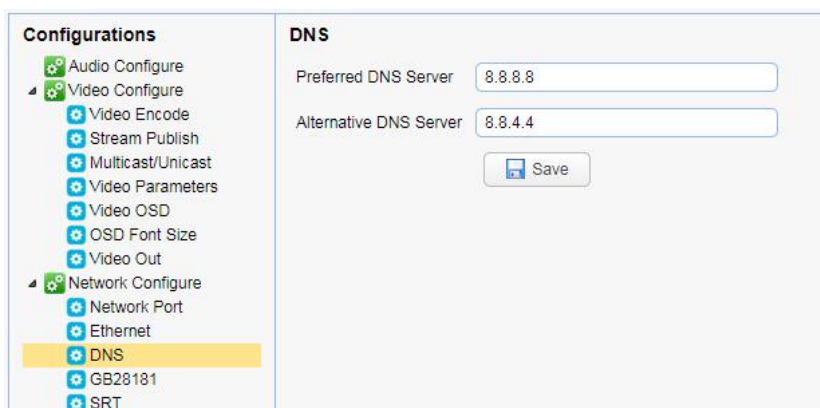

Step 2:

Create an event on Facebook and get the following info from Facebook.

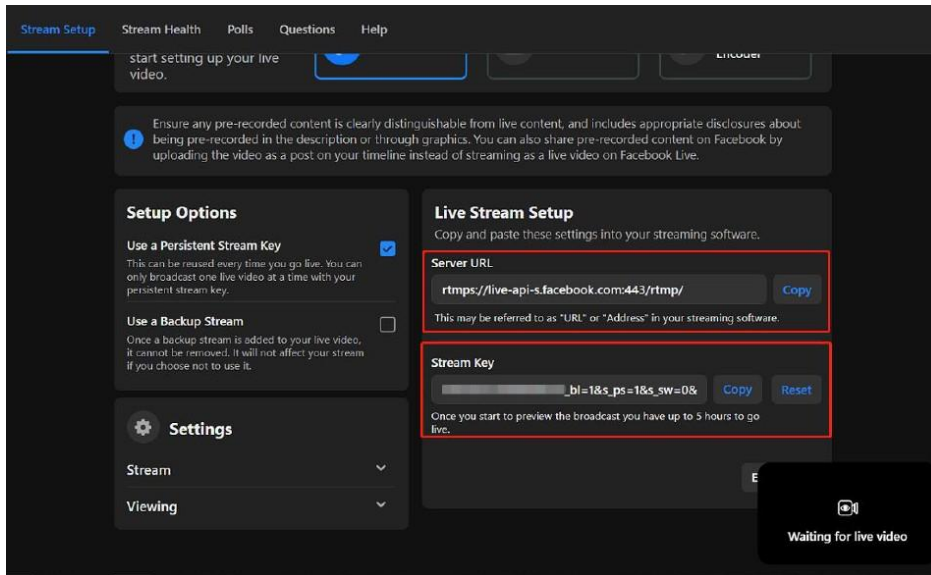

Facebook will give you two parameters, "stream key" and "server URL"

Step 3:

Fill these two parameters into the "host address" and "stream name" of the camera, and change the port to 443

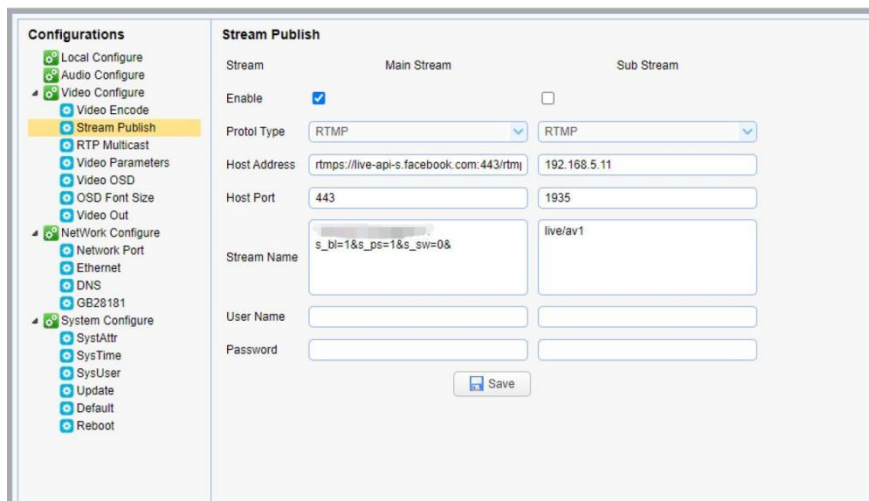

8. Example: Streaming to Youtube

Streaming to Youtube is similar as streaming to Facebook.

Port Type: RTMP

Host Port: 1935

Host Address = Youtube "Stream URL"

Stream Name = Youtube "Stream Key"

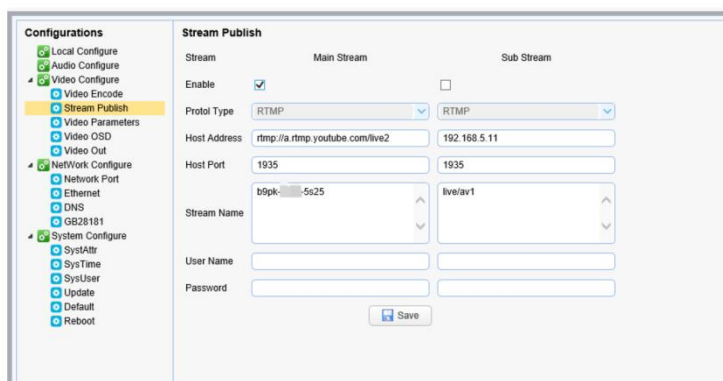

9. Example: Streaming to Vmix

(1) Click “Add Input”

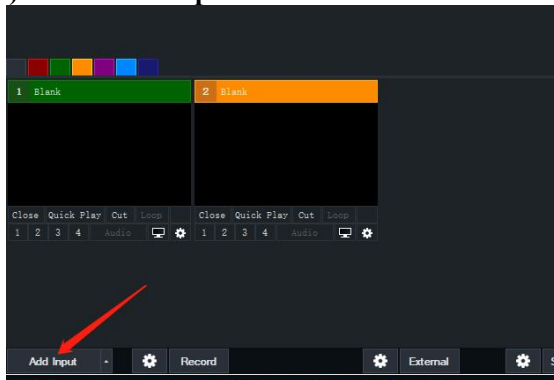

(2) Stream/SRT -> Choose VLC

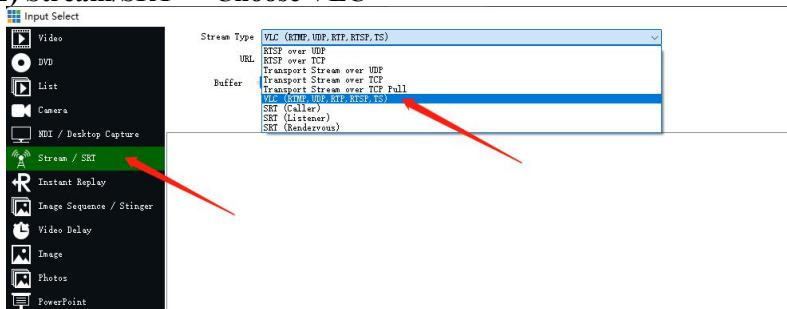

(3) Input camera’s RTSP URL:

rtsp://192.168.0.100:554/live/av0

Please change the IP address to your camera’s ip address.

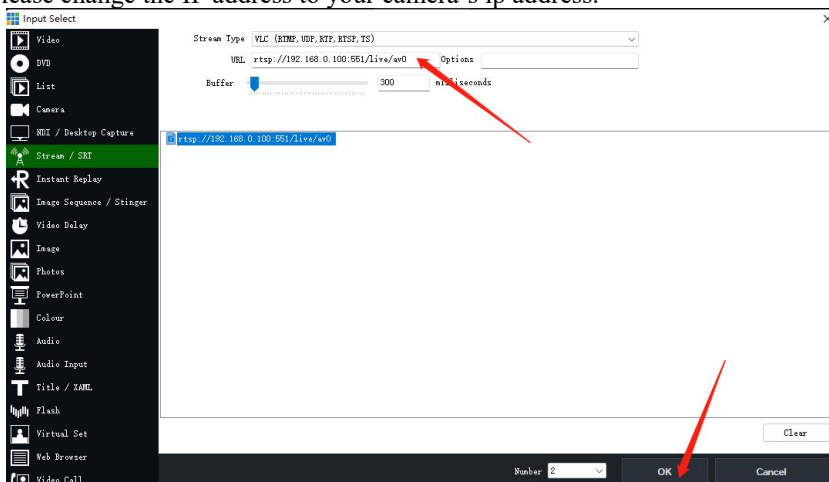

Then,press “OK”, it will stream to Vmix successfully.

And it is similar method to stream to other live streaming software.

10. Copyright Statement

All the contents in this manual and its copyright are owned by the company. No one is allowed to imitate, copy, or translate this manual without the company’s permission. This manual contains no guarantee, standpoint expression or other implies in any form. Product specification and information in this manual is for reference only and subject to change without notice.

All rights reserved. No reproducing is allowed without acknowledgement.