

FOMaKo

PTZ Camera Controller

(KC608 Pro & KC608N)

User Manual V1.0



FOMaKo

E-mail: ivan@fomako.net

Website: www.fomako.net

Phone: 0086-18565635753

Address: 10F NiuLanQian Building, Minzhi,
longhua, shenzhen, China, 518000

Please feel free to contact us if you have any questions.

Please Note: Both controller and camera have NDI function, then, they can use NDI control protocol.

Quick Start

◆ Add Controller&Cameras to Your Network

Please do the connections as the following. You'd better have a router in your network, then router will assign IP addresses for the controller and cameras automatic. If you don't have router in your network, controller&cameras can't get IP address from your network.

Network Connection

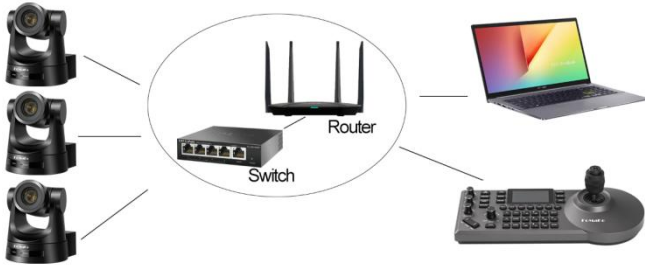

◆ About cameras and controller's IP address

The first three parts of IP address must be the same for controller and cameras.
For example:

192.168.1.100 and **192.168.1.150**, the first three parts are the same. You can add the camera to controller.

192.168.1.100 and **192.168.12.110**, the first three parts are not the same. You can't add the camera to the controller.

You have to change camera or controller's ip address, to make the first three parts become the same.

FoMaKo cameras and controller are optimized, normally, you don't need change ip address for them.

◆ Add Cameras to Controller

Method one: By controller's search function

Please note: Some brands cameras don't support search function.

Let's use FoMaKo camera for example.

- (1) Press "search" button on controller, it will show cameras' ip address on screen;
- (2) Press "Enter" -> "Add to Shortcut Keys", you can assign the cameras to CAM1~CAM7 shortcut keys,

For example, you assigned the first camera to CAM 1, press "CAM 1" button, now, you can control the first camera.

- (3) Add cameras one by one, you can assign 7 cameras to 7 shortcut keys.

Method Two: by camera's IP address

- (1) Press "Setting" -> Device Management -> Add a new Device: input the camera's IP address, Protocol: VISCA Over IP, Save

- (2) Go to Settings -> Hot Key -> CAM 1 -> Select from List -> choose the camera's ip

address you just added->Press “enter” button to confirm ->Back.

Now, you add CAM 1 to controller successfully

◆ **Set and Call Preset Position**

Press “STORE” button, the button will light up, then you can save preset position by numbers;

Press “CALL” button, the button will light up, then you can call preset position by numbers.

◆ **Screen Preview Function**

“PVW” button control the camera’s video preview on the screen. But you need do the settings before using it.

PVW function uses camera’s RTSP streaming function. So, you need know your camera’s RTSP streaming URL.

Let’s use FoMaKo camera for example:

FoMaKo camera’s RTSP streaming URL is :

Main streaming: rtsp://192.168.1.100:554/live/av0

Second Streaming: rtsp://192.168.1.100:554/live/av1

Please change ip address **192.168.1.100** to your camera’s ip address.

Normally, we use second streaming for PVW function.

Settings on Controller:

(1) Long press the camera’s shortcut key, such as “CAM 1” , go to CAM 1’s settings -> Stream URL

(2) Input camera’s RTSP streaming URL: rtsp://192.168.1.100:554/live/av1 ,

(3) Press “enter to save”

(4) Press “PVW” button, now, the camera’s preview video will shown on screen

(5) Press “PVW” button again, it will close the preview video.

Tips:

(1) When go the the controller’s settings, you can use the “Focus” button to choose the settings. The operation will be much more faster.



(2) Save more than 10 position presets: Settings-> Keys->Preset Operation Mode ->255

If you need more supports, please contact us at: ivan@fomako.net, normally, we can reply you within 12hours

Contents

1、 Contents.....	1
2、 Tips/Precautions/Affirm.....	2
3、 Feature.....	3
4、 Product diagram.....	4
5、 Interface pin definition.....	6
6、 Power supply/IP connection/Serial connection.....	7
7、 Keyboard OSD menu settings/Keyboard input /Menu introduction.....	9
8、 Camera assignment.....	14
9、 Edit shortcut/Interact with the camera/Camera menu control.....	16
10、 Camera menu control.....	17
11、 NDI protocol control.....	18
12、 Specifications.....	19

Tips

Thank you for using our products.

In order to enable you to operate this machine proficiently as soon as possible, please carefully read the instruction manual we provide for you, from which you can obtain product safety precautions, product introduction and product usage methods and other related knowledge. After you have read the instruction manual, please keep it properly for future reference.

If you find any problems during the use of the product, please contact our relevant service personnel, thank you for your cooperation.

Precautions

1. Before connecting to the device, make sure the power supply voltage is correct. Only use the original uncut (unspliced) power supply that came with your keyboard.
2. If the product does not work properly, please contact your dealer. Never attempt to disassemble the device yourself. (We are not responsible for problems caused by unauthorized repair or maintenance.)
3. This product is an indoor device, please do not place this product in a place with water or humidity.
4. When transporting, the equipment should be packed in the original packaging.
5. Do not drop or subject the unit to physical impact.
6. Do not use strong detergent to clean the machine, when the dust is thick, wipe gently with a neutral detergent, and only for external cleaning.
7. Keep RJ-45 ports free of dust and moisture.
8. Avoid moving the machine between places that are too cold or too hot to avoid fogging inside the machine and affect its service life.

Affirm

1. We have done our best to complete and correct the content of this manual, but there will inevitably be errors and omissions, and we will not be responsible for any technical or printing errors in this manual.
2. The appearance of the product shown in this manual is for reference only, and may differ from the actual appearance of the device you purchased.
3. This instruction manual guides multiple product models, so it is not intended to be used alone for any specific product.
4. The display interfaces in this manual, illustrations, parameters, drawings and model value ranges may be different. Please refer to the actual product for details.
5. The content of this manual is subject to change without prior notice.
6. If there is a discrepancy with this manual due to software version upgrades, please refer to the software as the standard.

Feature

- **4D precise Joystick+3D knobs+ergonomic zoom button:**

Camera parameters control such as white balance, exposure, focus and zoom etc.

- **Built-in 3-inch LCD screen:**

Support real-time PVW of current camera viewing through up streaming (NDI HX2 and RTSP only).

- **Support 7 cameras selection shortcuts:**

7 camera shortcuts can be set quickly according to requirements; Up to 1000 cameras information can be saved.

- **Newly upgraded UI operation interface:**

Display main parameters of cameras directly, personalize stylish interface casually.

- **Remote control of PTZ camera menu:**

Open camera's menu quickly and combine PVW screen or image screen to control.

* This function is recommended to be used with our camera.

- **White and red backlight silicone buttons:**

High-quality silicone, excellent touch, support white and red backlight so it can be operated smoothly in a low-light environment; support letters and common characters input and other operations such as editing camera's name and address.

- **Support buttons lock via one click:**

Lock buttons via one click to avoid misoperation.

- **Multiple control protocols, apply to abundant venues:**

Support VISCA、VISCA Over IP、VISCA TCP、PELCO P/D、Onvif and NDI, support automatic protocol recognition.

*Additional licenses are required to upgrade the NDI function, please consult the manufacturer for details.

- **Abundant interfaces, multiple connection methods:**

External RS-232, RS422/485 serial port and RJ45 network interface. The network interface supports POE function, thereby reducing wiring trouble.

- **External tally interface:**

Support up to 8 tally channels.

- **Support customizable buttons:**

Support customizable buttons F1, F2, can set the best operation function according to requirement.

Product diagram

The Frontboard:

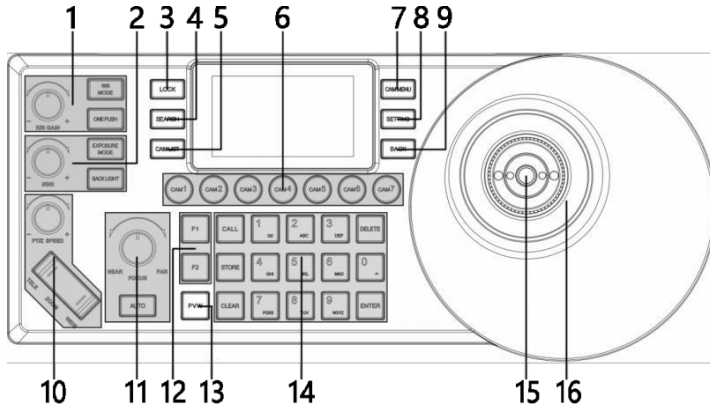



Button Function:

1. White balance adjustment
 - “WB MODE” white balance mode selection
 - “ONE PUSH” trigger, white balance is triggered when the controller is in “ONE PUSH” mode. “R/B GAIN”white balance adjustment
2. Exposure adjustment
 - “EXPOSURE MODE” exposure mode selection
 - “BACKLIGHT” turn on/off backlight
 - “I/S/G”exposure adjustment
3. “LOCK”, lock keyboard
4. “SEARCH”for searching IP device; support VISCA OVER IP / ONVIF protocol search
5. “CAM LIST”, IP device list
6. “CAM1~CAM7”, shortcut buttons to select cameras
7. “CAM MENU”, camera menu, turn on/off
8. “SETTING”, control keyboard settings
9. “BACK”, back button
10. Optical zoom adjustment
 - “PT/Z SPEED”, knob to adjust the zoom speed level (1~7)
 - “ZOOM” TELE WIDE, control camera’s optical zoom
11. Focus adjustment
 - “NEAR”, manual focus mode, near focus
 - “FAR”, manual focus mode, far focus “AUTO”, auto focus mode
12. “F1~F2”, customizable buttons
13. “PVW”, preview current-controlled device, IP video streaming
14. Preset operation area: characters, number keyboard
15. HOME: confirmation button (VISCA)
16. PTZ joystick
 - The left and right direction of the joystick is panning, and the up and down is tilting. When you release the joystick, the camera will stop moving.
 - Turn the knob on the joystick clockwise, ZOOM TELE; Turn the knob on the joystick anticlockwise, ZOOM WIDE.

Product diagram

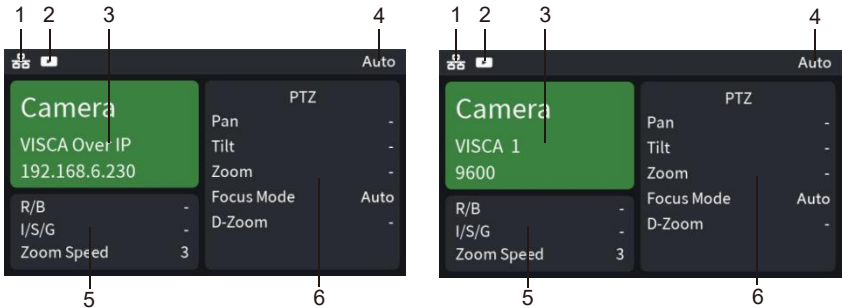
Screen:



1. Network connection indicator icon "  " indicates that the network has been connected successfully;
2. Preview video indicator icon "  " indicates that current device you control has the preview video streaming;
3. Control camera through network, it shows device name, control protocol, device IP address respectively;
Control camera through Serial port, it shows device name, control protocol, device ID address, baud rate respectively;
4. Operation record area;
5. "R/B" is current mode of "R/B GAIN" knob;
"I/S/G" is current mode of "I/S/G" knob;
"Zoom speed" is current mode of "PTZ SPEED" knob;

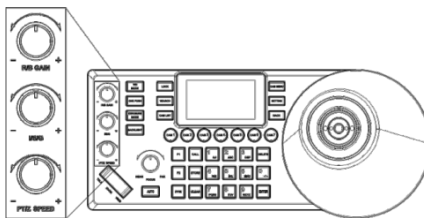

6. Camera's current mode display area.

Product diagram



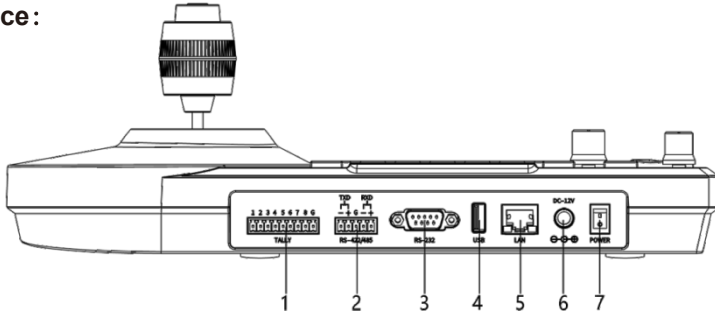

Interface :

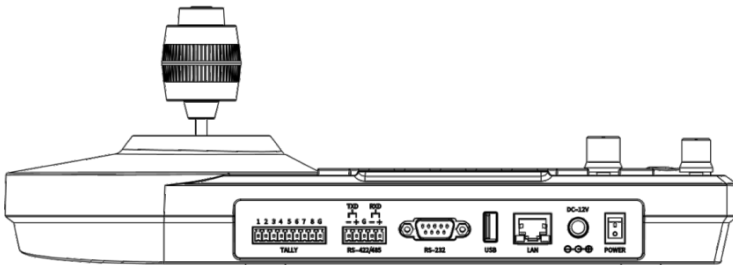

1. Tally interface;
2. RS-422/485 interface;
Connect with RS-422 cable, up to 7 cameras can be controlled through VISCA protocol; Connect with RS-485 cable, up to 7 cameras can be controlled through VISCA protocol and up to 255 cameras through PELCO protocol.
3. RS-232 interface;
Connect with RS-232 cable, up to 7pcs cameras can be controlled through VISCA and up to 255pcs cameras through PELCO protocol.
4. USB interface (reserved interface, no function);
5. LAN port, connect the controller with network (up to 1000 network cameras can be saved);
6. DC-12V power input interface;
7. Power on/off.

Interface pin definition



 TALLY		 RS-422/485		 RS-232		 LAN			
Pin NO	Function	Pin NO	RS-422 Function	RS-485 Function	Pin NO	Function	Pin NO	Function	Color
1	Tally1				1	NC	1	TXD+	Orange/White
2	Tally2	1	TXD-	B-	2	RXD	2	TXD-	Orange
3	Tally3	2	TXD+	A+	3	TXD	3	RXD+	Green/White
4	Tally4	3	GND	GND	4	NC	4	POE45	Blue
5	Tally5	4	RXD-	/	5	GND	5	POE45	Blue/White
6	Tally6	5	RXD+	/	6	NC	6	RXD-	Green
7	Tally7				7	NC	7	POE78	Brown/White
8	Tally8				8	NC	8	POE78	Brown
8	Tally8				9	NC			
G	GND								

Power supply

Supply controller's power by the following methods 1.DC power adapter power supply (standard 12V)

2.POE power supply (connect the Ethernet IP port to the POE switch) Use CAT6 cable, the maximum distance is 100 meters (802.3af)

IP connection

Connect "LAN" port of the controller to port on the Ethernet switch

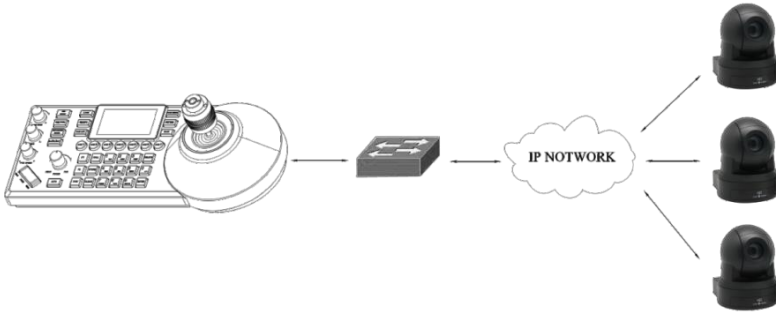

Serial connection

1. Connect DB9 to RS232 8 pin mini port control cable for RS-232 connection RS232 interface picture

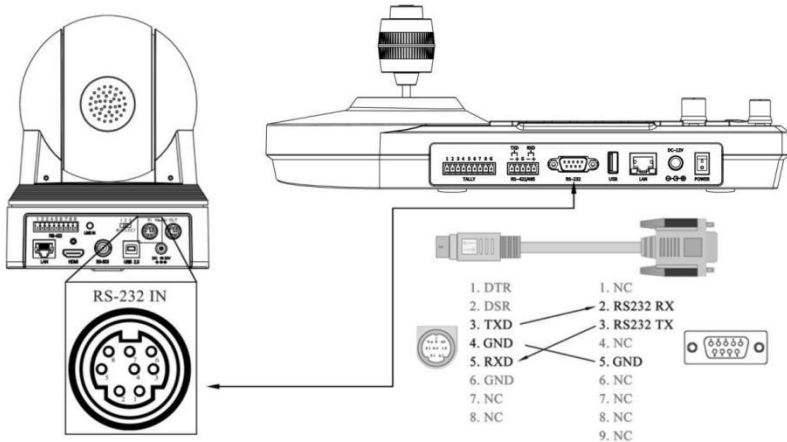

Serial connection

2. Phoenix head for RS-422 connection

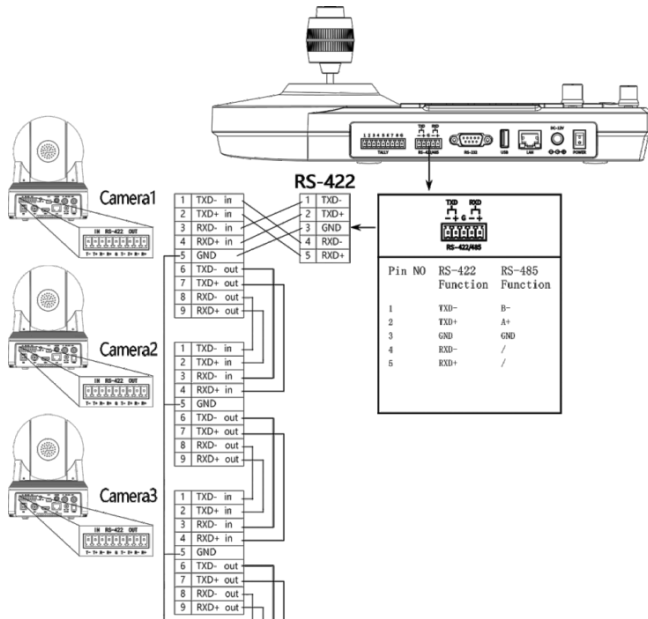

3. Phoenix head for RS-485 connection

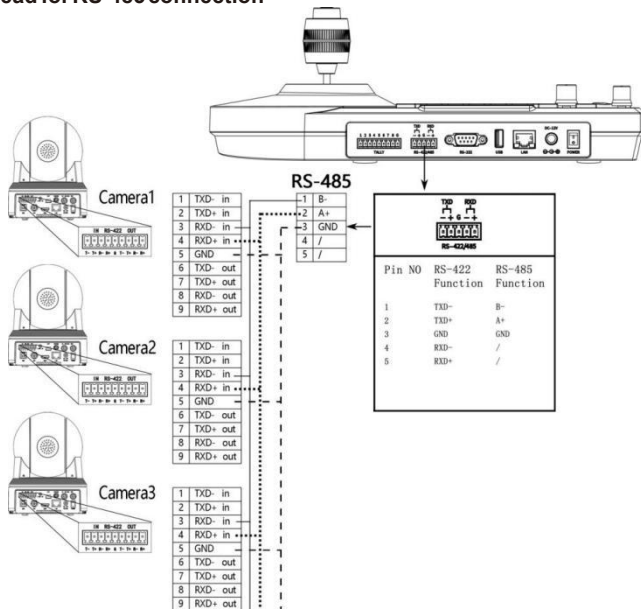

Keyboard OSD menu settings

- Press the "SETTING" button to open / exit the keyboard menu Use
- the joystick to operate the keyboard menu
 - a. Move the joystick cursor up and down
 - b. Move the joystick to the right to enter the next menu / switch parameters
 - c. Move the joystick to the left to return to the previous menu / switch parameters
 - d. "HOME" button on the top of the joystick to enter the next menu / save and exit Use
- the "FOCUS" knob to operate the keyboard menu
 - a. Rotate the cursor clockwise down
 - b. Rotate the cursor counterclockwise up
 - c. Click the "FOCUS" knob to enter the next menu / save and exit
- Click the "BACK" "AUTO" to return to the previous menu / exit without saving

Keyboard input

- Each button with number and letter or symbol input, select the character you want to input by clicking the button continuously
- Adjust the cursor position by rotating the joystick left or right or the "FOCUS" knob Case
- switching:
 - a. Click the button "1" twice continuously to switch to uppercase English
 - b. Click the button "1" three times continuously to switch to lowercase English
- "DELETE" : delete a single character
- "ENTER", "HOME" : save and exit "BACK",
- "AUTO": do not save and exit

Menu introduction

Main menu list

Settings	
√ . Hot Key	>
√ . Protocol Settings	>
√ . Network	>
√ . Keys	>
√ . Display	>
√ . Beep	>
√ . Joystick	>
√ . Tally	>
√ . Language	English >
√ . About Device	>
√ . Reset Device	>

Hot Key: It is used to set the device information of CAM1~CAM7 shortcut keys;

Device Management :Used to manage the keyboard neglect device and added device information;

Protocol Settings: Authorization and information management for the corresponding protocol of the controller;

Network:Used to manage network setting;

Keys:Used to set up the custom functions of the buttons F1 and F2, and the preset operation mode; **Display:**Used for setting up the display of controller;

Beep:Beep happens when operate the buttons; **Joystick:**Set up joystick related functions;

Tally:The controller is used to send and receive tally signals;

Language:Set the keyboard display language;

About Device:Display equipment information (the following information is given by the manufacturer and cannot be modified without permission. If you have any questions, please contact the manufacturer);

Reset Device:Restore to factory default setting state

Menu introduction

1. Hot Key

Hot Key		Camera Information	
√. CAM1	>	√. Device Name	Camera 1 >
√. CAM2	>	√. Protocol	VISCA ∨
√. CAM3	>	√. Address	1 ∨
√. CAM4	>	√. Baudrate	9600 ∨
√. CAM5	>	√. RS-485	<input type="checkbox"/>
√. CAM6	>	√. Compatible Mode	Normal ∨
√. CAM7	>	√. Video Stream	RTSP ∨
		√. Stream URL	rtsp://>
		√. Reset Camera Address	>
		Select from List	>

VISCA
Pelco D Pelco
P VISCA Over
IP VISCA TCP
ONVIF
NDI

Device Name: Modify the device name which is displayed on the home page;

Protocol: Select a protocol based on your needs, "VISCA", "PELCO D", "PELCO P", "VISCA Over IP", "VISCA TCP" can be manually input, "ONVIF" and "NDI" cannot be manually selected, needs to be selected from the device list;

Address: match the camera address;

Baudrate: match the camera baud rate;

RS-485: When using the RS-485 connection mode to connect to the camera, turn on this option to obtain the device information status;

Compatible mode: When it has problem to use the standard mode to work with the camera, pls try to use other modes;

Video stream: A protocol that supports video streaming over a network;

Stream URL: Enter the camera stream address to pull the video signal of the camera; Reset

Camera address: When cascading multiple cameras and using the VISCA protocol, this function can assign corresponding addresses to the cameras according to the connection sequence (only valid under the VISCA protocol);

Select from list: You can select a device from the "device list" for quick control.

2. Device Management

Device Management	
Device List	>
Add a New Device	>
Ignored Device List Add	>
an Ignored Device	>

Device list: You can delete the device that has been added to the keyboard or modify the device information that has been added to the keyboard;

Add a new device: Manually add devices to the keyboard; Ignored device list: block specified devices in the search list;

Add an ignored device: Manually add devices that need to be blocked in the search list.

Menu introduction

3. Protocol settings

Protocol settings	
√. NDI	>

Authorization and information management for the corresponding protocol of the controller.

4. Network

Network	
√. DHCP	
√. IP Address	192. 168. 1. 119>
√. Net Mask	255. 255. 255. 0>
√. Gateway	192. 168. 1. 1>
√. DNS1	192. 168. 1. 1>
√. DNS2	8. 8. 8. 8>
√. Extra IP1	OFF>
√. Extra IP2	OFF>
√. Extra IP3	OFF>

DHCP: DHCP ON means network-related IP address can be attained automatically (dynamic address), DHCP OFF means network-related IP address need to be added manually (static address);

Extra IP 1/2/3: You can manually add the IP of other network segments, and after enabling it, it can be used to control cameras in other different network segments in the LAN (should be used when DHCP is off).

5. Keys

Keys	
√. F1	>
√. F2	>
√. Preset Operation Mode	10

F1/F2: You can customize the functions of the buttons F1 and F2.

a. Switch page: Switch the display mode of the current camera's status, the modes include "PTZ", "Exposure" and "White Balance";

b. Custom command: Power: Control camera standby/ startup (long press for 2 seconds to take effect); Digital zoom: Turn on/off the digital zoom function of the camera;

(The above two functions only take effect under the VISCA and VISCA Over IP protocols).

Preset operation mode: optional button to select the preset position as 10 or 255 mode;

Relatively speaking, the preset position 10 mode is faster than the preset position 255 mode, but the preset position 255 mode can call more preset positions than the preset position 10 mode;

For detailed operation methods please turn to the "Setting, Calling, and Deleting Presets" item for reference.

Menu introduction

6. Display

Display	
√. Theme Color	Green ▾
√. Brightness	High ▾
√. Key Brightness	Medium ▾
√. Auto Sleep	<input type="checkbox"/>

Theme color: Modify the display color of the controller theme (after the modification, power off and reboot to take effect) ;

Brightness: Modify the screen brightness; Key brightness: modify the buttons brightness;

Auto sleep: the controller will sleep after 30 minutes when you turn on the automatic sleep, and the buttons and screen brightness become low.

7. Beep

Beep	
√. Enable	<input checked="" type="checkbox"/>
√. Style	Style1 ▾

On: the buzzer works when prompt tone is turned on, and there is sound feedback when the buttons are pressed;

Style: select the prompt tone style.

8. Joystick

Joystick	
√. Zoom Enable	<input checked="" type="checkbox"/>
√. Pan Reverse	<input checked="" type="checkbox"/>
√. Tilt Reverse	<input checked="" type="checkbox"/>
√. Correction	>

Zoom Function: After turning on, rotate the joystick to control the zoom of the camera;

Pan Reverse: Turn on, the left and right direction is reversed when you control the camera;

Tilt Reverse: Turn on, the up and down direction is reversed when you control the camera; Calibration:

When the joystick is abnormal, try to calibrate the joystick according to the prompts (click the "BACK" button to back from the calibration mode).

9. Tally

Tally	
√. Enable	<input checked="" type="checkbox"/>
√. Mode	Input ▾
√. Camera Link	<input checked="" type="checkbox"/>

Enable: Tally signals can be received and sent after being turned on;

Mode: The controller can be selected as tally signal output or input;

Camera Link: Turn it on, connect the camera with tally light, when the camera is connected with the protocol that supports tally signal, the tally light of the camera will receive the signal and respond.

Menu introduction

10. Language

Language	
√ . Language	English ▾
	English
	简体中文

Set the keyboard display language.

11. About Device

About Device	
√ . Firmware Version	V0.0.24 >
√ . Authorization	Authorized
√ . Serial Number	B66CD8B163
√ . MAC Address	54:87:62:21:25:33

Firmware version: display the current program version of the keyboard;

Authorization: display the current authorization status of the keyboard (unauthorized keyboards can only be used for 30 minutes, and cannot be operated beyond 30 minutes);

Serial number: display keyboard serial number; **MAC address:** display keyboard MAC address.

12. Reset device

Reset device	
√ . Reset Settings	>
√ . Reset Settings and Data	>

Reset settings: restore the keyboard basic menu setting options to the factory state (network settings, language, user-added device data will not be restored);

Reset settings and data: restore all keyboard settings and clear all device data added by users.

Camera assignment

Add IP camera to keyboard

1. Search the local network and add the IP camera to the keyboard;

- Press "SEARCH" button to search IP camera;
- The keyboard screen displays "Searching for devices, please wait";
- Display the discovered ONVIF / VISCA_IP cameras, use the joystick or "FOCUS" knob to browse the discovered cameras;

(For discovered cameras, camera parameters can be modified, added to the camera list, and added to the ignore list);

- Edit discovered cameras and add cameras to the camera list (device that has been added to the camera list will no longer be displayed in the search list);
- Exit the search list;
- Press the "CAME LIST" button to open the camera list, use the joystick or the "FOCUS" knob to select the corresponding camera.

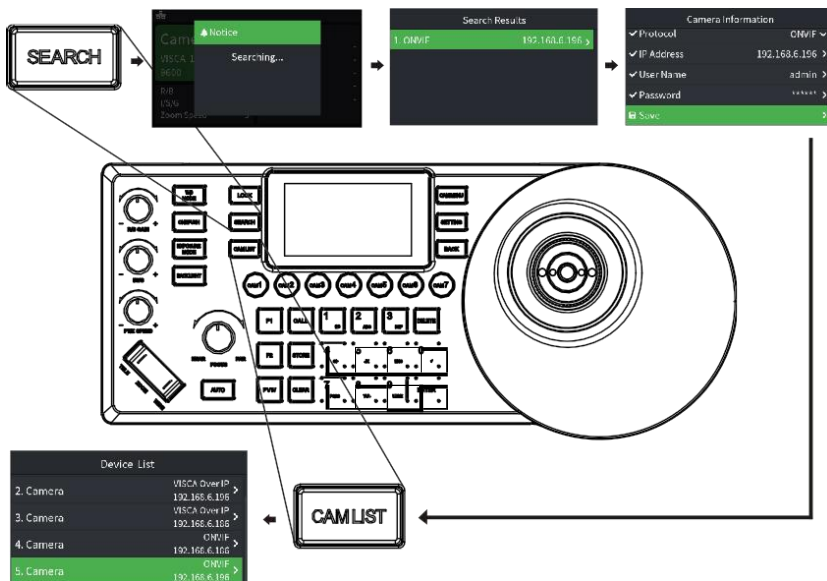

Camera assignment

2. Manually add VISCA_IP, VISCA_TCP cameras to the keyboard:

- Click "SETTING" to open the keyboard menu, select the "Device List" column, select the "Add Device" column, modify the corresponding camera parameters and click "Save" (when the IP address needs to fill in an odd number, add 00 before the odd number, such as 005);
- Exit keyboard menu;
- Short press the "CAM LIST" button to open the camera list, use the joystick to select the added custom camera (IP control).

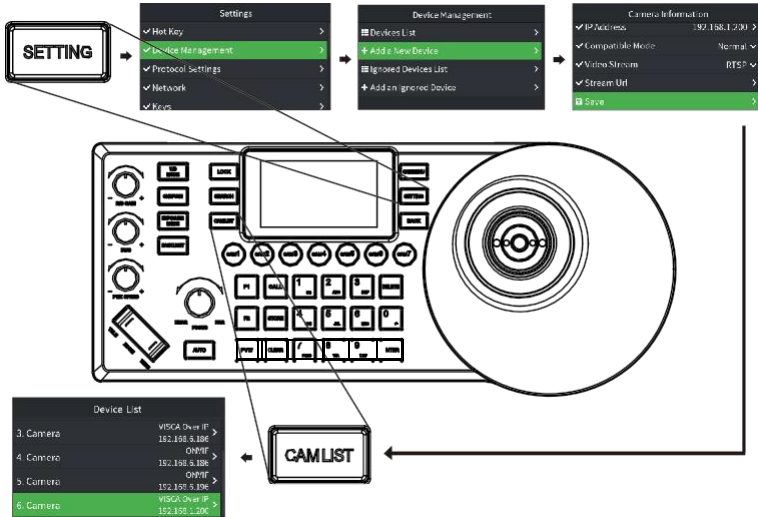

3. Edit camera list

- Click "SETTING" to enter the menu, select "Device Management" column, select "Device List"
- It can edit the devices added to the camera list from the "search list" and "add list"; (You can edit camera name, protocol (ONVIF and NDI device list does not allow manual selection), IP address, compatibility mode, video stream address, delete device, ONVIF device settings can also edit user name and password)

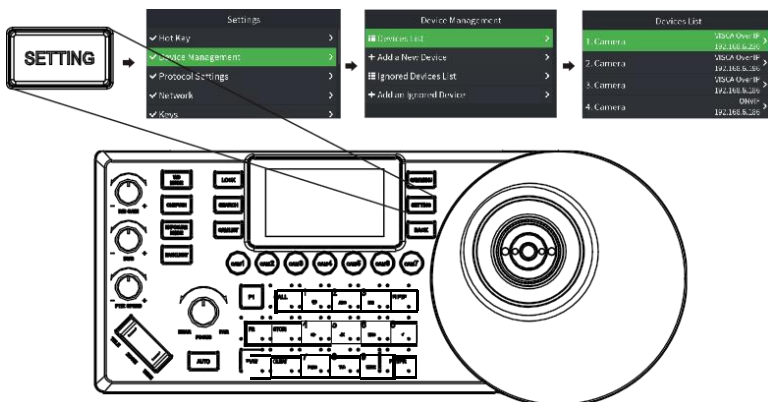

Edit shortcut

- Click "SETTING" to enter the menu, select the "Shortcut Key" column, you can edit 7 shortcut keys, take the shortcut key CAM1 as an example, you can manually modify the device parameters;

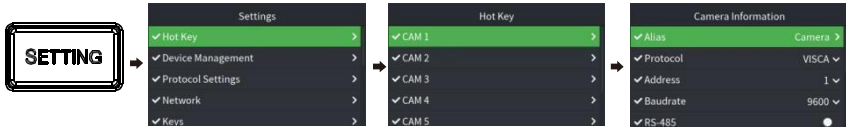

- You can select the "Select from List" column to select a device from the "Device List";



- On the main page, when you have selected the shortcut key, press and hold for three seconds to quickly enter the shortcut key device editing, which is equivalent to the shortcut key device information editing in the menu.

Interact with the camera

- Click "CAM LIST" to open the device list, and then select the device through the joystick or "FOCUS" knob;
- Press the shortcut key "CAM1~CAM7" to select camera to be controlled; (When it's VISCA protocol, there are multiple cameras, in protocol for VISCA shortcut editing, click "Reset Camera Address" to assign the address).

Camera menu control

1. Set camera OSD menu

- Press the "CAM MENU" button to send a command to open the camera OSD menu; Use the
- joystick to navigate the menu;
 - Move the joystick up and down to browse the menu options;
 - Move left and right to adjust the value;
 - Press the top button of the joystick to send the "ENTER" command.

2. Manual movement

- Horizontal, vertical and zoom can be executed simultaneously;
- Joystick can be used to move horizontally and vertically in any direction;
- The joystick can quickly return the gimbal and lens to the initial position through the top button;
- PTZ Speed: "+, -" knob can adjust the rocker switch ("ZOOM" TELE WIDE) to control the zoom speed of the camera;
- Rotate the rocker to adjust Zoom In/Out.

Camera menu control

3. Set, recall and delete preset position

● set preset position

- a. Move the camera to the desired position;
- b. ① The preset position mode is 10: first press the "STORE" key, and then press the number "1" key to set the No. 1 preset position;
- ② The preset position mode is 255: first press the "STORE" key, and then press the number "1" key, and then press the "ENTER" key to set the No. 1 preset position;
- c. The upper right corner of the keyboard screen displays "Save Preset 1";

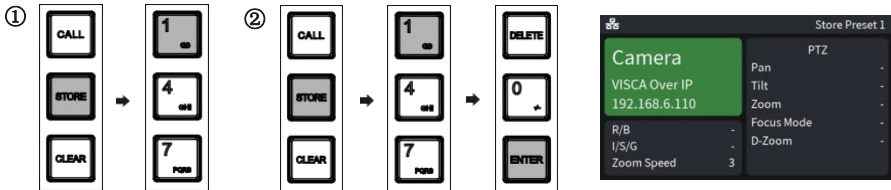

● Call

- a. ① The preset position mode is 10: first press the "CALL" key, and then press the number "1" key to call the No. 1 preset position;
- ② The preset position mode is 255: first press the "CALL" key, then press the number "1" key, and then press the "ENTER" key to call the No. 1 preset position;
- b. The upper right corner of the keyboard screen displays "Recall Preset 1";

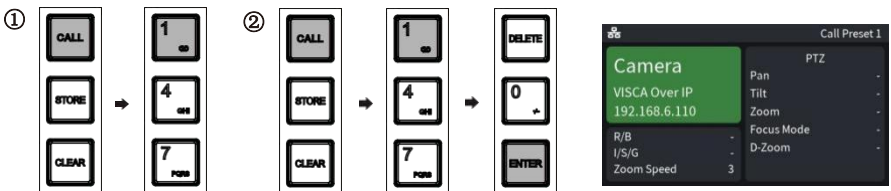

● Delete

- a. ① The preset position mode is 10: first press the "CLEAR" key, and then press the number "1" key to delete the No. 1 preset position;
- ② The preset position mode is 255: first press the "CLEAR" key, then press the number "1" key, and then press the "ENTER" key to delete the No. 1 preset position;
- b. The upper right corner of the keyboard screen displays "Delete Preset 1".

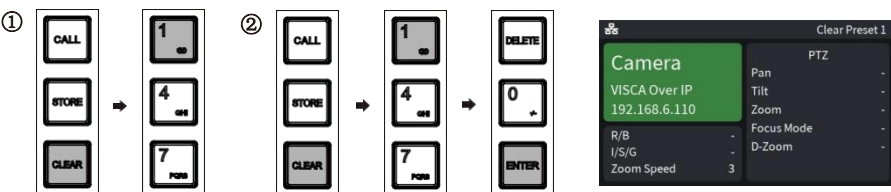

Camera menu control

4. Adjust image parameters

Use the image adjustment panel to set or adjust image parameters (only applicable to VISCA and VISCA_IP protocols, PELCO /ONVIF/NDI protocol image adjustment function is incomplete);

Backlight compensation

- Turn on/off the camera's backlight compensation via the "BACK LIGHT" button;

Exposure

- The exposure mode can be switched through the "EXPOSURE MODE" button; Adjust the
- parameter value in each mode by rotating the "I/S/G +/-" knob; Parameter switching in the
- same mode, click the "I/S/G +/-" knob to switch (aperture, shutter, gain);

White balance

- Switch the white balance mode by using the "WB MODE" button;
- By clicking the "R/B GAIN +/-" knob, switch the red/blue gain value parameter adjustment;

Focus

- Manually adjust the focus (near/far) through the FOCUS knob "NERA/FAR" knob; Automatic
- adjustment by using the AUTO button.

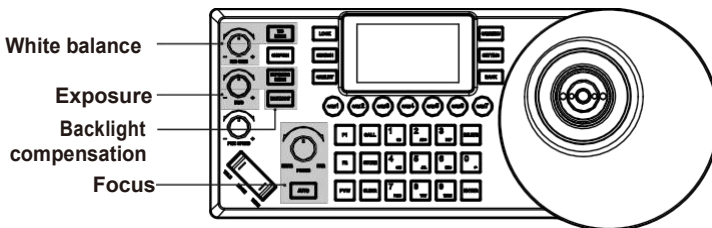

NDI protocol control

Connect the camera and keyboard in the same LAN;

Press "CAM LIST" to open the camera list, use the joystick or the "FOCUS" knob to select the corresponding NDI protocol camera (for cameras that support NDI protocol, the IP will be automatically added to the camera list when the network is connected, no need to search and add); (Visca Over IP, Onvif protocols need to search for devices first and then manually add IP to the camera list.)

Device List	
6. Camera	VISCA Over IP 192.168.6.110
7. NDI PTZ CAMERA (NDI Strea	NDI 192.168.6.62
8. NDI PTZ CAMERA (NDI Strea	NDI 192.168.6.110
9. NDI PTZ CAMERA (NDI Strea	NDI 192.168.6.186

Specifications

Keyboard Parameters	
Joystick	4D precision Joystick
Knobs	3Dknobs,support scale rotation to adjust parameters, support button
Buttons	High-Quality silicone buttons, support white and red two-color backlight
Screen	3"LCD color display
Shortcut Button	Support 7 camera shortcut button settings
Button Prompt Tone	Button sound prompt On/Off
Lock Button	Support one-key lock function
Max.ControlQuantity	1000
Max.Preset Position	255
Control	
Control Interface	RJ45 (support POE and NDI HX2)、RS-232、RS-422/485
IP Control Protocol	Onvif、VISCA Over IP、VISCA TCP、NDI
Serial Port Protocol	VISCA、Pelco D、Pelco P
PowerSupply	
Input Voltage	12V
Input Current	0.25A
POE	802.3af
Rated Power	3W
Other	
Tally	Support up to eight channels
Operating Environment	Indoor
Operating Temperature	-10℃ -40℃
Storage Temperature	-20℃-60℃
Dimensions	332*136*58mm (Joystick height is not included)
	332*136*116mm (Joystick height is included)
Weight	About 1.0 kg